



LISTINO PREZZI **2023/1**

PRICE LIST

TARIF

PREISLISTE

ПРАЙС-ЛИСТ

Cerasarda is a brand of



CERASARDA SI RISERVA LA FACOLTÀ DI MODIFICARE IN QUALUNQUE MOMENTO LE INFORMAZIONI E LE CARATTERISTICHE TECNICHE ILLUSTRATE NEL PRESENTE LISTINO, CHE NON SONO COMUNQUE DA RITENERE LEGALMENTE VINCOLANTI. PESI E MISURE POSSONO SUBIRE VARIAZIONI TIPICHE DEL PARTICOLARE PROCESSO DI COTTURA DEL MATERIALE CERAMICO.

TUTTI I FORMATI SI INTENDONO NOMINALI, COME DA TABELLA SU LISTINO. CONSIGLI DI POSA E PULIZIA SUL SITO WEB, WWW.CERASARDA.IT

CERASARDA RESERVES THE RIGHT, AT ANY TIME AND WITHOUT PRIOR NOTICE, TO CHANGE THE INFORMATION AND TECHNICAL CHARACTERISTICS GIVEN IN THIS PRICE LIST NONE OF WHICH ARE TO BE CONSIDERED LEGALLY BINDING. WEIGHTS AND DIMENSIONS ARE SUBJECT TO THE NORMAL VARIATIONS RESULTING FROM THE CERAMIC FIRING PROCESS.

ALL SIZES ARE TO BE CONSIDERED NOMINAL, AS SHOWN ON THE TABLE IN THE PRICE LIST. LAYING AND CLEANING SUGGESTION ON WEBSITE WWW.CERASARDA.IT

CERASARDA SE RÉSERVE LE DROIT DE MODIFIER À TOUT MOMENT LES INFORMATIONS ET LES CARACTÉRISTIQUES FIGURANT SUR LE TARIF LESQUELLE NE SAURAIENT, EN TOUT ÉTAT DE CAUSE, ENGAGER JURIDIQUEMENT L'ENTREPRISE. LE POIDS ET LES DIMENSIONS PEUVENT SUBIR DES VARIATIONS, DUES AU PROCESSUS DE CUISSON PARTICULIER DU MATÉRIAU CÉRAMIQUE. TOUTS LES FORMATS INDIQUÉS SONT LES FORMATS NOMINAUX, COMME POUR LE TABLEAU FIGURANT DANS NOTRE TARIF. CONSEILS DE POSE ET DE NÉTOYAGE SUR LE SITE WWW.CERASARDA.IT .

CERASARDA BEHÄLT SICH DAS RECHT VOR, DIE IN DIESER PREISLISTE ENTHALTENEN ANGABEN UND TECHNISCHEN EIGENSCHAFTEN JEDERZEIT ZU VERÄNDERN UND ALS UNVERBINDLICH ZU BETRACHTEN. GEWICHTE UND ABMESSUNGEN KÖNNEN INFOLGE DES BESONDEREN BRENNVERFAHRENS DES KERAMIKMATERIALS ÄNDERN. ALLE FORMATE VERSTEHEN SICH ALS NENNFORMATE GEMASS DER TABELLE IN DER PREISLISTE. VERLEGE- UND REINIGUNGSHINWEISE AUF DER WEBSEITE WWW.CERASARDA.IT

ALLA RICEZIONE DELLA MERCE, IL CLIENTE È TENUTO A VERIFICARE CHE IL PRODOTTO CONSEGNATO SIA CONFORME A QUANTO DICHIARATO NEL D.D.T. (DOCUMENTO DI TRASPORTO). NON SI ACCETTANO RECLAMI PER MATERIALE CONSEGNATO IN CANTIERE IN DIFFORMITÀ DA QUANTO RIPORTATO NEL DOCUMENTO STESSO. QUALORA FOSSE RISCOSTRATA DIFFORMITÀ, IL GRUPPO ROMANI SI ASSUMERÀ I COSTI DI TRASPORTO PER L'EVENTUALE SOSTITUZIONE/INTEGRAZIONE DELLA QUANTITÀ DI PRODOTTO NON CONFORME. PER OGNI RICHIESTA DI RESO DOVUTA AD ERRORI DI ORDINE, RINUNCIA DA PARTE DEL CLIENTE O COMUNQUE PER MOTIVI NON IMPUTABILI ALL'AZIENDA, SARÀ RICHIESTO UN CONTRIBUTO PARI AL 10% DEL VALORE DELLA MERCE RESA.

UPON RECEIPT OF THE GOODS, THE CUSTOMER HAS TO VERIFY THAT THE MATERIAL IS COMPLIANT TO WHAT DECLARED IN THE TRANSPORT DOCUMENT. COMPLAINTS FOR MATERIAL THAT DOES NOT CORRESPOND TO WHAT DECLARED IN THE TRANSPORT DOCUMENT THAT HAS ALREADY BEEN DELIVERED TO JOB SITE WILL NOT BE ACCEPTED. GRUPPO ROMANI WILL BE RESPONSIBLE FOR COST OF TRANSPORT AND EVENTUAL REPLACEMENT OR SUPPLY OF MATERIAL THAT HAS BEEN FOUND TO BE NOT COMPLIANT TO WHAT DECLARED IN THE TRANSPORT DOCUMENT.

FOR ANY REQUEST FOR GOODS TO BE RETURNED DUE TO ORDER ERRORS, REFUSAL BY THE CUSTOMER OR IN ANY CASE FOR REASONS NOT ATTRIBUTABLE TO THE COMPANY, A CONTRIBUTION OF 10% OF THE VALUE OF THE GOODS RETURNED WILL BE REQUIRED.

AU MOMENT DE RÉCEPTION DE LA MARCHANDISE, LE CLIENT DOIT CONTRÔLER QUE LE PRODUIT REÇU SOIT CONFORME À CE QU'IL Y A MARQUÉ DANS LE BULLETIN DE LIVRAISON. L'USINE N'ACCEPTERA PAS DE RÉCLAMATION POUR DU MATÉRIEL LIVRÉ SUR LE CHANTIER QUI N'EST PAS CONFORMÉ À CE QU'IL Y A ÉCRIT DANS LE BULLETIN DE LIVRAISON. LORSQU'IL Y AURA LE CONSTAT DE MARCHANDISE NON CONFORME, GRUPPO ROMANI PRENDRA CHARGE DES FRAIS DE TRANSPORT POUR L'ÉVENTUEL REMPLACEMENT ET/OU INTÉGRATION DE LA QUANTITÉ DE PRODUIT NON CONFORME. POUR TOUTE DEMANDE DE RETOUR EN RAISON D'ERREURS DE COMMANDE, DE RENONCIATION DE LA PART DU CLIENT OU POUR TOUTE AUTRE RAISON NON IMPUTABLE À LA SOCIÉTÉ, UNE CONTRIBUTION DE 10 % DE LA VALEUR DE LA MARCHANDISE RETOURNÉE SERA DEMANDÉE AU CLIENT.





NACH ERHALT DER WARE VERPFLICHTET SICH DER KUNDE, DIE GELIEFERTERTE WARE ZU KONTROLLIEREN, INSBESONDERE DIE ÜBEREINSTIMMUNG MIT DEN DATEN DES LIEFERSCHEINS.

FÜR AUF DIE BAUSTELLE GELIEFERTEN MATERIAL, DAS DIE ANGABEN DES LIEFERSCHEINS NICHT ENTSPRICHT WIRD KEINE REKLAMATION AKZEPTIERT.

WENN DIE GELIEFERTERTE WARE DIE DATEN DES LIEFERSCHEINS NICHT ENTSPRICHT WIRD GRUPPO ROMANI DAS MATERIAL AUSTAUSCHEN BZW. ERSETZEN UND DIE TRANSPORTKOSTEN BIS ZU DEM KUNDEN TRAGEN.

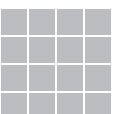
FÜR JEDE FORDERUNG AUF RÜCKERSTATTUNG AUF GRUND VON BESTELLUNGSFEHLERN, VERZICHT DURCH DEN KUNDEN ODER AUS NICHT DEM UNTERNEHMEN ZUZUSCHREIBENDEN GRÜNDEN, WIRD EINE KOSTENBETEILIGUNG VON 10% DES WERTS DER RÜCKERSTATTETEN WARE VERLANGT.

VARIAZIONE DI TONO - SHADE VARIATIONS - VARIATIONS DE NUANCE - TONVARIATIONEN

 <p>V1 ASPETTO UNIFORME UNIFORM APPEARANCE ASPECT UNIFORME EINHETLICHES AUSSEHEN</p>	 <p>V2 LIEVE VARIAZIONE SLIGHT VARIATION LEGERE VARIATION GERINGE ABWEICHUNG</p>	 <p>V3 MODERATA VARIAZIONE MODERATE VARIATION VARIATION MODEREE MÄSSIGE ABWEICHUNG</p>	 <p>V4 FORTE STONALIZZAZIONE SUBSTANTIAL VARIATION EFFET DENUANCE TRES ACCENTUE AKZENTUIERTE VARIATION</p>
---	--	--	--

IL PRESENTE LISTINO ANNULLA E SOSTITUISCE OGNI LISTINO PRECEDENTE. THIS PRICE LIST CANCELS AND REPLACES ANY PREVIOUS PRICE LIST
CE TARIF ANNULE ET REMPLACE TOUS LES PRÉCÉDENTS . DIESE PREISLISTE ANNULLIERT UND ERSETZT DIE VORHERIGE PREISLISTE.

IVA E TRASPORTO ESCLUSI, PALLET € 10,00, MINI PALLET € 7,00, BIG PALLET € 18,00/30,00. VAT AND TRASPORT NOT INCLUDED, PALLET € 10,00, MINI PALLET € 7,00, BIG PALLET € 18,00/30,00. TVA ET TRANSPORT NON INCLUS, PALLET € 10,00, MINI PALLET € 7,00, BIG PALLET € 18,00/30,00. MWST UND TRANSPORT NICHT INBEGRIFFEN, PALLET € 10,00, MINI PALLET € 7,00 BIG PALLET € 18,00/30,00.

CE
GRUPPO ROMANI S.P.A. INDUSTRIE CERAMICHE VIA A. VOLTA 9, 23/25 42013 CASALGRANDE (RE)
05 001CPR2013-07-01
EN 14411:2012
Piastrelle di ceramica pressate a secco, con assorbimento di acqua $E_w \leq 0,5\%$, per pavimentazioni interne ed esterne. Dry pressed ceramic tile, with water absorption $E_w \leq 0,5\%$, for internal and external floorings.



© Copyright 2023 Gruppo Romani S.p.A.







Gruppo Romani S.p.A. Industrie Ceramiche
www.grupporomanispa.com



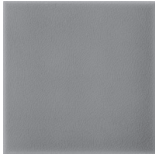

Ceramics of Italy

ABITARE LA TERRA - TINTE D'ACCENTO _____	24
I COTTI FATTI A MANO _____	11
DECORI STORICI _____	14
LE OSSIDIANE _____	22
MODULO MONDO 17 _____	18
OT07026 _____	15
PITRIZZA/MAREZZATI _____	04
SARDINIA _____	09
SUGHERO _____	26
TINTÙRI _____	05
TRASPARENZE MARINE _____	20
YACHT CLUB _____	27
TOP BAGNO IN LAVA VULCANICA _____	28
PIATTI DOCCIA IN LAVA VULCANICA _____	29
LAVELLI _____	31
APPENDICE TECNICA _____	32



FORMATO NOMINALE Nominal Size Format Nominal Nennformat	SPESSORE Thickness Epaisseur Stärke mm	ARTICOLO Item Article Artikel	1° SCELTA PREZZO SFUSO 1 st Choice loose price 1 Choix prix en vrac 1 wahl preis lose €.mq	BOX			PALLET			
				PEZZI Pieces Pièces Stücke	MQ Sqm Mc Qm	KG	SCATOLE Boxes Boîtes Kartons	MQ Sqm Mc Qm	KG	
BICOTTURA IN PASTA ROSSA - RED BODY DOUBLE-FIRED TILES										
20x20 cm 8"x8" 	10	ACQUA MARINA AZZURRO MARE BIANCO PLAYA BLU CUGNANA BLU MAESTRALE BLU NAVY BLU OLTREMARE BLU PETROLIO GIADA SARDINIA GRIGIO MOYEN	LILLA MANDARINO MIELE NERO PERVINCA ROSA TURCHESE ABBAMAR VERDE SALVIA VERDE SMERALDO VIGONE	mq € 98,00	25	1,00	16,00	51	51,00	830
		ROSSO VIVO		mq € 108,00						
10x30 cm 4"x12" 	10	ACQUA MARINA AZZURRO MARE BIANCO PLAYA BLU CUGNANA BLU MAESTRALE BLU NAVY BLU OLTREMARE BLU PETROLIO GIADA SARDINIA GRIGIO MOYEN	LILLA MIELE NERO PERVINCA ROSA TURCHESE ABBAMAR VERDE SALVIA VERDE SMERALDO VIGONE	mq € 106,00	25	0,75	17,34	55	41,25	970
		ROSSO VIVO		mq € 116,00						
10x20 cm 4"x8" 	10	ACQUA MARINA AZZURRO MARE BIANCO PLAYA BLU MAESTRALE BLU NAVY BLU OLTREMARE BLU PETROLIO GIADA SARDINIA GRIGIO MOYEN LILLA	MANDARINO MIELE NERO PERVINCA ROSA TURCHESE ABBAMAR VERDE SALVIA VERDE SMERALDO VIGONE	mq € 100,00	25	0,50	9,00	80	40,00	735
		ROSSO VIVO		mq € 110,00						
10x10 cm 4"x4" 	10	ACQUA MARINA AZZURRO MARE BIANCO PLAYA BLU CUGNANA BLU MAESTRALE BLU NAVY BLU OLTREMARE BLU PETROLIO GIADA SARDINIA GRIGIO MOYEN	LILLA MANDARINO MIELE NERO PERVINCA ROSA TURCHESE ABBAMAR VERDE SALVIA VERDE SMERALDO VIGONE	mq € 104,00	50	0,50	8,50	80	40,00	695
		ROSSO VIVO		mq € 114,00						
TOZZETTO 5x5 cm 2"x2" 	10	ACQUA MARINA AZZURRO MARE BIANCO PLAYA BLU CUGNANA BLU MAESTRALE BLU NAVY BLU OLTREMARE BLU PETROLIO GIADA SARDINIA GRIGIO MOYEN	LILLA MANDARINO MIELE NERO PERVINCA ROSA ROSSO VIVO TURCHESE ABBAMAR VERDE SALVIA VERDE SMERALDO VIGONE	pz € 3,00	20	0,05	1,30			
LISTELLO 3x20 cm 1 3/16"x8" 	10	ACQUA MARINA AZZURRO MARE BIANCO PLAYA BLU MAESTRALE BLU NAVY BLU OLTREMARE BLU PETROLIO GIADA SARDINIA GRIGIO MOYEN	LILLA NERO PERVINCA ROSSO VIVO TURCHESE ABBAMAR VERDE SMERALDO	pz € 10,00	19	0,114	2,10			

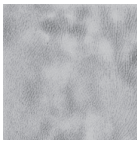

FORMATO NOMINALE Nominal Size Format Nominal Nennformat	SPESSORE Thickness Épaisseur Stärke mm	ARTICOLO Item Article Artikel	1° SCELTA PREZZO SFUSO 1 st Choice loose price 1 Choix prix en vrac 1 wahl preis lose €.mq	BOX			PALLET		
				PEZZI Pieces Pièces Stücke	MQ Sqm Mc Qm	KG	SCATOLE Boxes Boîtes Kartons	MQ Sqm Mc Qm	KG
BICOTTURA IN PASTA ROSSA - RED BODY DOUBLE-FIRED TILES									
20x20 cm 8"x8" 	10	MAREZZATO ACQUA MARINA MAREZZATO AZZURRO MARE MAREZZATO BIANCO LUCIDO* MAREZZATO BLU MAESTRALE MAREZZATO BLU NAVY MAREZZATO GIADA SARINIA MAREZZATO TURCHESE ABBAMAR MAREZZATO VERDE SALVIA MAREZZATO VERDE SMERALDO	mq € 120,00	24**	0,961	15,36	51	48,96	800
10x10 cm 4"x4" 	10	MAREZZATO ACQUA MARINA MAREZZATO AZZURRO MARE MAREZZATO BIANCO LUCIDO* MAREZZATO BLU MAESTRALE MAREZZATO BLU NAVY MAREZZATO GIADA SARINIA MAREZZATO TURCHESE ABBAMAR MAREZZATO VERDE SALVIA MAREZZATO VERDE SMERALDO	mq € 140,00	48**	0,48	8,80	80	38,40	350

* LA SUPERFICIE DEL BIANCO LUCIDO NON È CRAQUELÉ. BIANCO LUCIDO TEXTURE IS NOT CRAQUELÉ.
LA SURFACE DU BIANCO LUCIDO N'EST PAS CRAQUELÉE. DIE OBERFLÄCHE DER FARBE, BIANCO LUCIDO* IST NICHT CRAQUELÉ.

** TRATTANDOSI DI MATERIALE REALIZZATO A MANO, IN FUNZIONE DELLO SPESSORE I PEZZI PER SCATOLA POTREBBERO VARIARE.
AS THESE ARE HANDMADE MATERIALS, THE UNITS PER BOX MAY VARY DUE TO THICKNESS DIFFERENCE.
S'AGISSANT D'UN PRODUIT FAIT À LA MAIN, LES PIÈCES DES BOÎTES PEUVENT ÊTRE SUJETTES À VARIATION EN FONCTION DE L'ÉPAISSEUR.
DA ES SICH UM HANDGEFERTIGTES MATERIAL HANDELT, KÖNNTE DIE JEWEILS IN DEN SCHACHTELN ENTHALTENE STÜCKZAHL IN FUNKTION DER MATERIALDICKE VERÄNDERLICH SEIN.



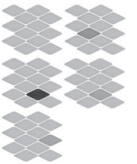



FORMATO NOMINALE Nominal Size Format Nominal Nennformat	SPESSORE Thickness Épaisseur Stärke mm	ARTICOLO Item Article Artikel	1° SCELTA PREZZO SFUSO 1 st Choice loose price 1 Choix prix en vrac 1 wahl preis lose €.mq	BOX			PALLET			
				PEZZI Pieces Pièces Stücke	MQ Sqm Mc Qm	KG	SCATOLE Boxes Boîtes Kartons	MQ Sqm Mc Qm	KG	
BICOTTURA IN PASTA ROSSA - RED BODY DOUBLE-FIRED TILES										
FOGLIO 24,5x23 cm 9 ⁵ / ₈ "x9 ¹ / ₆ " (ROMBO) 12,2x6,2 cm 4 ¹³ / ₁₆ "x2 ⁷ / ₁₆ "  (SU FOGLI DI RETE IN FIBRA)	10	ALPINO (COMPOSTO DA ROMBI: 6 PZ VERDE SMERALDO, 6 PZ NERO) BALLANTYNE (COMPOSTO DA ROMBI: 3 PZ PERVINCA, 3 PZ GIADA SARINIA, 2 PZ BLU NAVY, 2 PZ GRIGIO MOYEN, 2 PZ AZZURRO MARE) CASHMIRE (COMPOSTO DA ROMBI: 6 PZ GRIGIO MOYEN, 2 PZ ROSA, 4 PZ BIANCO PLAYA) DANUBIO (COMPOSTO DA ROMBI: 5 PZ BLU NAVY, 4 PZ NERO, 3 PZ BLU PETROLIO) LIBECCIO (COMPOSTO DA ROMBI: 6 PZ GIADA SARINIA, 3 PZ TURCHESE ABBAMAR, 3 PZ ACQUA MARINA) MARIPOSA (COMPOSTO DA ROMBI: 3 PZ MANDARINO, 3 PZ BLU MAESTRALE, 3 PZ ACQUA MARINA, 3 PZ ROSA) OLEANDRO (COMPOSTO DA ROMBI: 6 PZ VERDE SMERALDO, 3 PZ LILLA, 3 PZ BLU PETROLIO) PISCINA (COMPOSTO DA ROMBI: 6 PZ ACQUA MARINA, 3 PZ TURCHESE ABBAMAR, 3 PZ PERVINCA) POSIDONIA (COMPOSTO DA ROMBI: 6 PZ AZZURRO MARE, 3 PZ VERDE SMERALDO, 3 PZ BLU NAVY) VICHY (COMPOSTO DA ROMBI: 6 NERO, 6 PZ BIANCO PLAYA)	fg € 28,00	10	0,56	9,00				
 (SU FOGLI DI RETE IN FIBRA)	10	NEVELUX S/5 (SET A 5 FOGLI, COMPOSTO DA ROMBI: 56 PZ BIANCO PLAYA, 1 PZ GIADA SARINIA, 1 PZ TURCHESE ABBAMAR, 1 PZ ACQUA MARINA, 1 PZ AZZURRO MARE) SETALUX S/5 (SET A 5 FOGLI, COMPOSTO DA ROMBI: 56 PZ NERO, 1 PZ GIADA SARINIA, 1 PZ BLU OLTREMARE, 1 PZ BLU NAVY, 1 PZ VERDE SMERALDO) LA COMPOSIZIONE ROMBO È DISPONIBILE ANCHE NELLA VERSIONE MONOCOLORE. SOLO SU ORDINAZIONE CON ORDINE MINIMO DI 100 FOGLI, SOLO NEI COLORI BIANCO PLAYA, GIALLO PANTOGIA E NERO. THE ROMBO COMPOSITION IS ALSO AVAILABLE ON SPECIAL ORDER IN SINGOL COLOR VERSION WITH MINIMUM ORDER QUANTITY 100 SHEETS, ONLY COLORS BIANCO PLAYA, GIALLO PANTOGIA AND NERO.	fg € 28,00	5	0,28	4,50				



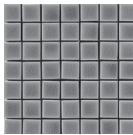
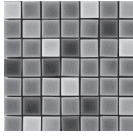

FORMATO NOMINALE Nominal Size Format Nominal Nennformat	SPESSORE Thickness Epaisseur Stärke mm	ARTICOLO Item Article Artikel	1° SCELTA PREZZO SFUSO 1 st Choice loose price 1 Choix prix en vrac 1 wahl preis lose €.mq	BOX			PALLET		
				PEZZI Pieces Pièces Stücke	MQ Sqm Mc Qm	KG	SCATOLE Boxes Boîtes Kartons	MQ Sqm Mc Qm	KG

BICOTTURA IN PASTA ROSSA - RED BODY DOUBLE-FIRED TILES

MOSAICI - MOSAICS - MOSAÏQUES - MOSAIKEN

	10	MOSAICO TESSERA AZZURRO MARE, GIADA SARDINIA, TURCHESE ABBAMAR, VERDE SMERALDO (SU FOGLI DI RETE IN FIBRA)	fg € 24,00	10	0,40	5,00			
	10	MOSAICO TESSERA MARE MIX (ACQUA MARINA, AZZURRO MARE, GIADA SARDINIA, TURCHESE ABBAMAR, VERDE SMERALDO) (SU FOGLI DI RETE IN FIBRA)	fg € 24,00	10	0,40	5,00			
	10	MOSAICO SPACCATELLA MONOCOLORE* AZZURRO MARE (SU FOGLI DI RETE IN FIBRA)	fg € 35,00	5	0,45	6,00			
		*IL MOSAICO SPACCATELLA MONOCOLORE È DISPONIBILE ANCHE NEGLI ALTRI COLORI DELLA SERIE, SOLO SU ORDINAZIONE, ORDINE MINIMO 20 FOGLI. SOLID COLOR SPACCATELLA MOSAIC IS AVAILABLE FOR SPECIAL ORDER ON ALL THE OTHER COLORS. MINIMUM ORDER IS 20 SHEETS.	fg € 40,00						
	10	MOSAICO SPACCATELLA BICOLORE* AZZURRO MARE/TURCHESE ABBAMAR MIX (SU FOGLI DI RETE IN FIBRA)	fg € 36,00	5	0,45	6,00			
		*IL MOSAICO SPACCATELLA BICOLORE È DISPONIBILE ANCHE NEGLI ALTRI COLORI DELLA SERIE, SOLO SU ORDINAZIONE, ORDINE MINIMO 20 FOGLI. SOLID DOUBLE COLOR SPACCATELLA MOSAIC IS AVAILABLE FOR SPECIAL ORDER ON ALL THE OTHER COLORS. MINIMUM ORDER IS 20 SHEETS.	fg € 41,00						
	10	MOSAICO SPACCATELLA MIX* (SU FOGLI DI RETE IN FIBRA)	fg € 50,00	5	0,45	6,00			
		*IL MOSAICO SPACCATELLA MIX È DISPONIBILE NEI COLORI DELLA SERIE SOLO SU ORDINAZIONE, ORDINE MINIMO 20 FOGLI MIX SPACCATELLA MOSAIC IS AVAILABLE FOR SPECIAL ORDER ON ALL OTHER COLORS. MINIMUM ORDER IS 20 SHEETS.							
	10	FASCIA SPACCATELLA MIX AZZURRO AZZURRO MARE/TURCHESE ABBAMAR MIX (SU FOGLI DI RETE IN FIBRA)	pz € 26,00	10					

PEZZI SPECIALI - SPECIAL PIECES - PIÈCES SPECIALES - SPEZIALTEILE

		ACQUA MARINA, AZZURRO MARE, BLU OLTREMARE, GIADA SARDINIA, ROSSO VIVO, TURCHESE ABBAMAR, VERDE SMERALDO	pz € 15,00	24					
		ACQUA MARINA, AZZURRO MARE, BIANCO PLAYA, GIADA SARDINIA, GRIGIO MOYEN, TURCHESE ABBAMAR, VERDE SMERALDO	pz € 14,00	24					

LAVELLI

		LAVELLO SPACCATELLA ROTONDO* (D'APPOGGIO) (PER GLI ABBINAMENTI, VEDI ARTICOLI MOSAICO SPACCATELLA) IMBALLO SPECIALE CON ADDEBITO DI € 15,00	pz € 950,00	1		12,00			
--	--	---	----------------	---	--	-------	--	--	--

* LAVELLI SPECIALI REALIZZATI A MANO SOLO SU ORDINAZIONE. IMBALLO SPECIALE CON ADDEBITO DI € 15,00 PER IL LAVELLO ROTONDO E € 17,00 PER QUELLO OVALE.
REALIZZABILE SIA MONOCOLORE CHE MIX.
CUSTOM MADE MADE BATHROOM SINK AVAILABLE FOR SPECIAL ORDER ONLY. EXTRA CHARGE OF € 15,00 FOR SPECIAL PACKAGING OF THE ROUND SINK AND € 17,00 FOR THE OVAL SINK.
AVAILABLE IN MONOCOLOR OR MIX.

IVA E TRASPORTO ESCLUSI, PALLET € 10,00, MINI PALLET € 7,00, PALLET BIG € 18,00/30,00 _ VAT AND TRASPOT NOT INCLUDED, PALLET € 10,00, MINI PALLET € 7,00, PALLET BIG € 18,00/30,00
TVA ET TRANSPORT NON INCLUS, PALLET € 10,00, MINI PALLET € 7,00, PALLET BIG € 18,00/30,00 _ MWST UND TRANSPORT NICHT INBEGRIFFEN, PALLET € 10,00, MINI PALLET € 7,00, PALLET BIG € 18,00/30,00









FORMATO NOMINALE Nominal Size Format Nominal Nennformat	SPESORE Thickness Epaisseur Stärke mm	ARTICOLO Item Article Artikel	1° SCELTA PREZZO SFUSO 1 st Choice loose price 1 Choix prix en vrac 1 wahl preis lose €.mq	BOX			PALLET		
				PEZZI Pieces Pièces Stücke	MQ Sqm Mc Qm	KG	SCATOLE Boxes Boîtes Kartons	MQ Sqm Mc Qm	KG

BICOTTURA IN PASTA ROSSA - RED BODY DOUBLE-FIRED TILES

LAVELLI

	LAVELLO SPACCATELLA OVALE* (D'APPOGGIO) (PER GLI ABBINAMENTI, VEDI ARTICOLI MOSAICO SPACCATELLA) IMBALLO SPECIALE CON ADDEBITO DI € 17,00	pz € 980,00	1	13,00					
l 59,50 cm p 46,50 cm h 15,50 cm 23 ⁷ / ₁₆ "-18 ⁵ / ₁₆ "-6 ¹ / ₈ "									

DECORI - DECORS - DÉCORS - DEKORE

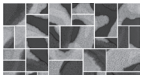
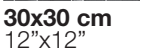











	10 OLIVASTRO INCISO ACQUA MARINA, AZZURRO MARE, BIANCO LUCIDO, BIANCO PLAYA, BLU MAESTRALE, GIADA SARDEGNA, MIELE, PERVINCA, ROSA, TURCHESE ABBAMAR, VERDE SMERALDO, VIGONE	pz € 3,00 mq € 180,00	12 50						
	10 ROSONCINO RILIEVO ACQUA MARINA, AZZURRO MARE, BIANCO LUCIDO, BIANCO PLAYA, BLU MAESTRALE, GIADA SARDEGNA, MIELE, PERVINCA, ROSA, TURCHESE ABBAMAR, VERDE SMERALDO, VIGONE	pz € 3,00 mq € 180,00	12 50						
	10 LOGO CERASARDA ACQUA MARINA, AZZURRO MARE, BIANCO LUCIDO, BIANCO PLAYA, BLU MAESTRALE, GIADA SARDEGNA, PERVINCA, ROSA, TURCHESE ABBAMAR, VERDE SMERALDO, VIGONE	pz € 3,00 mq € 180,00	12 50						
	10 LISTELLO SPARGI** (DECORATI A MANO) BLU, MIELE, VERDE	pz € 26,00	10						
	10 INSERTO SPARGI** (DECORATI A MANO) BLU, MIELE, VERDE	pz € 45,00	5						
	10 COSTA SMERALDA** (DECORATI A MANO) BLU, VERDE	mq € 530,00 pz € 26,00	24 8	0,96	18,00	39	37,44	718	
	10 ESAGONA COSTA SMERALDA** (DECORATI A MANO) BLU, VERDE	mq € 550,00 pz € 30,00	18 8	1,02	20,44	39	39,78	820	
	10 PRINCIPE S/4 BLU, VERDE	mq € 490,00 pz € 24,00	24 8	0,96	22,30	39	37,44	870	
	10 MOSAICO PRINCIPE BLU, VERDE	fg € 54,00	5						
	30x30 cm 12"x12"								

** SOGGETTI MISCELATI CASUALMENTE NELLE SCATOLE. DESIGNS AVAILABLE WITH EACH BOX CONTAINING A RANDOM MIX.
MOTIFS MÉLANGÉS AU HASARD DANS LES BOÎTES. DIE MUSTER IN DEN SCHACHTELN WERDEN NACH DEN ZUFALLSPRINZIP GEMISCHT.





FORMATO NOMINALE Nominal Size Format Nominal Nennformat	SPESSORE Thickness Epaisseur Stärke mm	ARTICOLO Item Article Artikel	1° SCELTA PREZZO SFUSO 1 st Choice loose price 1 Choix prix en vrac 1 wahl preis lose €.mq	BOX			PALLET		
				PEZZI Pieces Pièces Stücke	MQ Sqm Mc Qm	KG	SCATOLE Boxes Boîtes Kartons	MQ Sqm Mc Qm	KG

BICOTTURA IN PASTA ROSSA - RED BODY DOUBLE-FIRED TILES





DECORI - DECORS - DÉCORS - DEKORE

 5x20 cm 2"x8"	10	LISTELLO ONDA COTTO AZZURRO MARE, TURCHESE ABBAMAR	pz € 19,00	20					
 5x20 cm 2"x8"	10	LISTELLO ONDA AZZURRO MARE, TURCHESE ABBAMAR, VERDE SMERALDO	pz € 19,00	20					
 5x20 cm 2"x8"	10	LISTELLO PESCI ACQUA MARINA, AZZURRO MARE, TURCHESE ABBAMAR, VERDE SMERALDO	pz € 19,00	16					
 10x10 cm 4"x4"	10	FORMELLA PESCI S/3 ACQUA MARINA, VERDE SMERALDO	pz € 20,00	12					
 5x5 cm 2"x2"	10	INSERTO PESCI ACQUA MARINA, AZZURRO MARE,, TURCHESE ABBAMAR, VERDE SMERALDO	pz € 16,00	15					
 5x20 cm 2"x8"	10	LISTELLO PAVONCELLE ACQUA MARINA, AZZURRO MARE, TURCHESE ABBAMAR, VERDE SMERALDO	pz € 19,00	16					
 10x10 cm 4"x4"	10	FORMELLA PAVONCELLE S/3 ACQUA MARINA, AZZURRO MARE, TURCHESE ABBAMAR, VERDE SMERALDO	pz € 20,00	12					
 5x5 cm 2"x2"	10	INSERTO PAVONCELLE ACQUA MARINA, AZZURRO MARE, TURCHESE ABBAMAR, VERDE SMERALDO	pz € 16,00	15					
 5x20 cm 2"x8"	10	LISTELLO CONCHIGLIE ACQUA MARINA, AZZURRO MARE, TURCHESE ABBAMAR, VERDE SMERALDO	pz € 19,00	16					
 10x10 cm 4"x4"	10	FORMELLA CONCHIGLIE S/3 ACQUA MARINA, AZZURRO MARE, TURCHESE ABBAMAR, VERDE SMERALDO	pz € 20,00	12					
 5x5 cm 2"x2"	10	INSERTO CONCHIGLIE ACQUA MARINA, AZZURRO MARE, TURCHESE ABBAMAR, VERDE SMERALDO	pz € 16,00	15					
 20x20 cm 8"x8"	10	GALLURA CLASSICO S/8	mq € 470,00 pz € 24,00	24 8	0,96	22,50	39	37,44	894
 2x20 cm 13/16"x8"	10	MATITA METALLO SILVER	pz € 12,00	12					



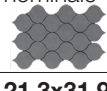

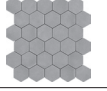
FORMATO NOMINALE Nominal Size Format Nominal Nennformat	SPESORE Thickness Epaisseur Stärke mm	ARTICOLO Item Article Artikel	1° SCELTA PREZZO SFUSO 1 st Choice loose price 1 Choix prix en vrac 1 wahl preis lose €.mq	BOX			PALLET		
				PEZZI Pieces Pièces Stücke	MQ Sqm Mc Qm	KG	SCATOLE Boxes Boîtes Kartons	MQ Sqm Mc Qm	KG
BICOTTURA IN PASTA ROSSA - RED BODY DOUBLE-FIRED TILES									
20x20 cm 8"x8" 	9	ACQUA AZZURRO MARE BIANCO PLAYA GIADA TURCHESE ABBAMAR	mq € 92,00	27	1,08	16,10	51	55,08	835
ARCHIVIO MIX (SOGGETTI MIX*) 20x20 cm 8"x8" 	9	ARCHIVIO MIX ACQUA ARCHIVIO MIX AZZURRO MARE ARCHIVIO MIX GIADA ARCHIVIO MIX TURCHESE ABBAMAR	mq € 100,00	27	1,08	16,10	51	55,08	835
20x40 cm 8"x16" 	9	ACQUA AZZURRO MARE BIANCO PLAYA GIADA TURCHESE ABBAMAR	mq € 92,00	14	1,12	17,00	72	80,64	1.240
ESAGONA 25,4x29,4 cm 10 ¹ / ₁₆ "x11 ⁹ / ₁₆ " 	10,5	ESAGONA ACQUA ESAGONA AZZURRO MARE ESAGONA BIANCO PLAYA ESAGONA GIADA ESAGONA TURCHESE ABBAMAR	mq € 100,00	18	1,02	20,44	39	39,78	820
ESAGONA ARCHIVIO MIX (SOGGETTI MIX*) 25,4x29,4 cm 10 ¹ / ₁₆ "x11 ⁹ / ₁₆ " 	10,5	ESAGONA ARCHIVIO MIX ACQUA ESAGONA ARCHIVIO MIX AZZURRO MARE ESAGONA ARCHIVIO MIX GIADA ESAGONA ARCHIVIO MIX TURCHESE ABBAMAR	mq € 108,00	18	1,02	20,44	39	39,78	820

MOSAICI - MOSAICS - MOSAÏQUES - MOSAIKEN

21,3x31,9 cm 8 ³ / ₈ "x12 ⁹ / ₁₆ " nominale 	9	MOSAICO GOCCIA <i>ACQUA, AZZURRO MARE, BIANCO PLAYA, GIADA, TURCHESE ABBAMAR</i> <i>(SU FOGLI DI RETE IN FIBRA)</i>	fg € 26,00	5	0,34	6,00			
21,3x31,9 cm 8 ³ / ₈ "x12 ⁹ / ₁₆ " nominal 	9	MOSAICO GOCCIA MIX <i>MIX AZZURRO, MIX VERDE</i> <i>(SU FOGLI DI RETE IN FIBRA)</i>	fg € 28,00	5	0,34	6,00			
27x27 cm 10 ⁵ / ₈ "x10 ⁵ / ₈ " nominale 	9	MOSAICO ESAGONA <i>ACQUA, AZZURRO MARE, BIANCO PLAYA, GIADA, TURCHESE ABBAMAR</i> <i>(SU FOGLI DI RETE IN FIBRA)</i>	fg € 31,00	5	0,36	7,00			
27x27 cm 10 ⁵ / ₈ "x10 ⁵ / ₈ " nominale 	9	MOSAICO ESAGONA MIX <i>MIX AZZURRO, MIX VERDE</i> <i>(SU FOGLI DI RETE IN FIBRA)</i>	fg € 33,00	5	0,36	7,00			

PEZZI SPECIALI - SPECIAL PIECES - PIÈCES SPECIALES - SPEZIALTEILE

SIGARO 2,5x20 cm 1"x8" 		<i>SERIE COMPLETA</i>	pz € 15,00	24					
PROFILO 1,2x20 cm 1/2"x8" 		<i>SERIE COMPLETA</i>	pz € 14,00	24					



* SOGGETTI MISCELATI CASUALMENTE NELLE SCATOLE. DESIGNS AVAILABLE WITH EACH BOX CONTAINING A RANDOM MIX.
MOTIFS MÉLANGÉS AU HASARD DANS LES BOÎTES. DIE MUSTER IN DEN SCHACHTELN WERDEN NACH DEN ZUFALLSPRINZIP GEMISCHT.







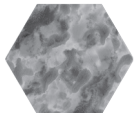
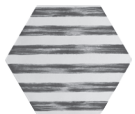

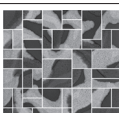
FORMATO NOMINALE Nominal Size Format Nominal Nennformat	SPESORE Thickness Epaisseur Stärke mm	ARTICOLO Item Article Artikel	1° SCELTA PREZZO SFUSO 1 st Choice loose price 1 Choix prix en vrac 1 wahl preis lose €.mq	BOX			PALLET		
				PEZZI Pieces Pièces Stücke	MQ Sqm Mc Qm	KG	SCATOLE Boxes Boîtes Kartons	MQ Sqm Mc Qm	KG

BICOTTURA IN PASTA ROSSA - RED BODY DOUBLE-FIRED TILES

DECORI - DECORS - DÉCORS - DEKORE

 10x20 cm 4"x8"	10	LISTELLO SPARGI* (DECORATI A MANO) BLU, MIELE, VERDE	pz € 26,00	10						
 20x20 cm 8"x8"	10	INSERTO SPARGI* (DECORATI A MANO) BLU, MIELE, VERDE	pz € 45,00	5						
 20x20 cm 8"x8"	10	COSTA SMERALDA* (DECORATI A MANO) BLU, VERDE	mq € 530,00 pz € 26,00	24 8	0,96	18	39	37,44	718	
 ESAGONA 25,4x29,4 cm 10 ¹ / ₁₆ "x11 ⁹ / ₁₆ "	10	ESAGONA COSTA SMERALDA* (DECORATI A MANO) BLU, VERDE	mq € 550,00 pz € 30,00	18 8	1,02	20,44	39	39,78	820	
 ESAGONA 25,4x29,4 cm 10 ¹ / ₁₆ "x11 ⁹ / ₁₆ "	10	ESAGONA GRANDE PEVERO BLU, VERDE	pz € 24,00	7						
 ESAGONA 25,4x29,4 cm 10 ¹ / ₁₆ "x11 ⁹ / ₁₆ "	10	ESAGONA PICCOLO PEVERO BLU, VERDE	pz € 24,00	7						
 ESAGONA 25,4x29,4 cm 10 ¹ / ₁₆ "x11 ⁹ / ₁₆ "	10	ESAGONA ROMAZZINO BLU, VERDE	pz € 24,00	7						
 ESAGONA 25,4x29,4 cm 10 ¹ / ₁₆ "x11 ⁹ / ₁₆ "	10	ESAGONA CAPRICCIOLI BLU, VERDE	pz € 24,00	7						
 20x20 cm 8"x8"	10	PRINCIPE S/4 BLU, VERDE	mq € 490,00 pz € 24,00	24 8	0,96	22,30	39	37,44	870	
 30x30 cm 12"x12"	10	MOSAICO PRINCIPE BLU, VERDE	fg € 54,00	5						

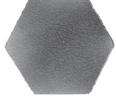
* SOGGETTI MISCELATI CASUALMENTE NELLE SCATOLE. DESIGNS AVAILABLE WITH EACH BOX CONTAINING A RANDOM MIX. MOTIFS MÉLANGÉS AU HASARD DANS LES BOÎTES. DIE MUSTER IN DEN SCHACHTELN WERDEN NACH DEN ZUFALLSPRINZIP GEMISCHT.

FORMATO NOMINALE Nominal Size Format Nominal Nennformat	SPESORE Thickness Epaisseur Stärke mm	ARTICOLO Item Article Artikel	1° SCELTA PREZZO SFUSO 1 st Choice loose price 1 Choix prix en vrac 1 wahl preis lose €.mq	BOX			PALLET			
				PEZZI Pieces Pièces Stücke	MQ Sqm Mc Qm	KG	SCATOLE Boxes Boîtes Kartons	MQ Sqm Mc Qm	KG	
COTTI FATTI A MANO - HANDMADE COTTO										
30x30 cm 12"x12" 	16	COTTO AMETISTA COTTO BIANCO PERLA COTTO CARAMEL COTTO GLICINE COTTO LAVANDA COTTO OCEANO BLU COTTO ORCHIDEA	COTTO AZZURRO MARE COTTO BIANCO LUCIDO COTTO GIADA SARDEGNA COTTO TURCHESE ABBAMAR COTTO VERDE ACQUA VALLAURIS AZZURRATO VALLAURIS BIANCO	mq € 225,00	7	0,63	22,00	34	21,42	760
		COTTO NERO ASSOLUTO COTTO SARDO COTTO VELATO	mq € 245,00							
20x20 cm 8"x8" 	16	COTTO AMETISTA COTTO BIANCO PERLA COTTO CARAMEL COTTO GLICINE COTTO LAVANDA COTTO OCEANO BLU COTTO ORCHIDEA	COTTO AZZURRO MARE COTTO BIANCO LUCIDO COTTO GIADA SARDEGNA COTTO TURCHESE ABBAMAR COTTO VERDE ACQUA VALLAURIS AZZURRATO VALLAURIS BIANCO	mq € 225,00	13	0,52	16,00	39	20,28	640
		COTTO NERO ASSOLUTO COTTO SARDO COTTO VELATO	mq € 245,00							
ROMBO 10x20 cm 4"x8" 	16	COTTO AMETISTA COTTO BIANCO PERLA COTTO CARAMEL COTTO GLICINE COTTO LAVANDA COTTO OCEANO BLU COTTO AZZURRO MARE	COTTO BIANCO LUCIDO COTTO GIADA SARDEGNA COTTO TURCHESE ABBAMAR COTTO VERDE ACQUA VALLAURIS AZZURRATO VALLAURIS BIANCO	mq € 370,00	36	0,36	12,00	35	12,60	435
		COTTO SARDO COTTO VELATO	mq € 390,00							
10x10 cm 4"x4" 	16	COTTO AMETISTA COTTO BIANCO PERLA COTTO CARAMEL COTTO GLICINE COTTO LAVANDA COTTO OCEANO BLU COTTO ORCHIDEA	COTTO AZZURRO MARE COTTO BIANCO LUCIDO COTTO GIADA SARDEGNA COTTO TURCHESE ABBAMAR COTTO VERDE ACQUA VALLAURIS AZZURRATO VALLAURIS BIANCO	mq € 225,00	50	0,50	14,00	35	17,50	505
		COTTO NERO ASSOLUTO COTTO SARDO COTTO VELATO	mq € 245,00							
ESAGONA 16x18 cm 4"x7 ¹ / ₁₆ " 	16	COTTO AMETISTA COTTO BIANCO PERLA COTTO CARAMEL COTTO GLICINE COTTO LAVANDA COTTO OCEANO BLU COTTO ORCHIDEA	COTTO AZZURRO MARE COTTO BIANCO LUCIDO COTTO GIADA SARDEGNA COTTO TURCHESE ABBAMAR COTTO VERDE ACQUA	mq € 270,00	18	0,396	10,26	36	14,26	386
		COTTO NERO ASSOLUTO COTTO SARDO COTTO VELATO	mq € 290,00							
RETTANGOLO 7x30 cm 2 ³ / ₄ "x12" 	16	COTTO AMETISTA COTTO BIANCO PERLA COTTO CARAMEL COTTO GLICINE COTTO LAVANDA COTTO OCEANO BLU COTTO ORCHIDEA	COTTO AZZURRO MARE COTTO BIANCO LUCIDO COTTO GIADA SARDEGNA COTTO TURCHESE ABBAMAR COTTO VERDE ACQUA VALLAURIS AZZURRATO VALLAURIS BIANCO	mq € 270,00	18	0,38	14,15	34	12,92	497
		COTTO SARDO COTTO VELATO	mq € 320,00							
TRIANGOLO 10x14 cm 4"x5 ¹ / ₂ " 	16	COTTO AMETISTA COTTO BIANCO PERLA COTTO GLICINE COTTO LAVANDA COTTO OCEANO BLU COTTO ORCHIDEA	COTTO AZZURRO MARE COTTO BIANCO LUCIDO COTTO GIADA SARDEGNA COTTO TURCHESE ABBAMAR COTTO VERDE ACQUA VALLAURIS BIANCO	pz € 11,00	22	0,11	3,08			
		COTTO SARDO COTTO VELATO	pz € 13,00							

FORMATO NOMINALE Nominal Size Format Nominal Nennformat	SPESSORE Thickness Epaisseur Stärke mm	ARTICOLO Item Article Artikel	1° SCELTA PREZZO SFUSO 1 st Choice loose price 1 Choix prix en vrac 1 wahl preis lose €.mq	BOX			PALLET		
				PEZZI Pieces Pièces Stücke	MQ Sqm Mc Qm	KG	SCATOLE Boxes Boîtes Kartons	MQ Sqm Mc Qm	KG

COTTI FATTI A MANO - HANDMADE COTTO

MOSAICI - MOSAICS - MOSAÏQUES - MOSAIKEN

30x30 cm 12"x12" 	PEPITE SFUSE (11 VASSOI = 1 MQ)	vassoio € 79,00						
	PEPITE SU RETE (MONOCOLORE) FOGLIO 30x30	fg € 87,00						
	PEPITE SU RETE MIX (BIANCO PERLA, AZZURRO MARE, TURCHESE ABBAMAR MIX) FOGLIO 30x30	fg € 90,00	3	0,45	4,80			
	PEPITE SU RETE (MIX A RICHIESTA) FOGLIO 30x30 COLORI: AMETISTA, BIANCO PERLA, ORCHIDEA, AZZURRO MARE, GIADA SARDINIA, TURCHESE ABBAMAR, VERDE ACQUA, GLICINE, LAVANDA, COTTO VELATO, COTTO SARDO	fg € 95,00						

PEZZI SPECIALI - SPECIAL PIECES - PIÈCES SPECIALES - SPEZIALTEILE

LISTELLO 3x20 cm 1 ¹³ / ₁₆ "x8" 	AMETISTA, BIANCO PERLA, GLICINE, LAVANDA, OCEANO BLU, ORCHIDEA, AZZURRO MARE, BIANCO LUCIDO, GIADA SARDINIA, TURCHESE ABBAMAR, VERDE ACQUA,	pz € 17,00	24					
	COTTO SARDO, COTTO VELATO	pz € 18,00	24					

DECORI - DECORS - DÉCORS - DEKORE

 20x20 cm 8"x8" 10x10 cm 4"x4"	16	DECORO CORALLO S/2 ROSSO (SU FONDO COTTO BIANCO LUCIDO)	pz € 48,00	6				
	16	DECORO CORALLO S/2 ROSSO (SU FONDO COTTO BIANCO LUCIDO)	pz € 27,00	6				
 20x20 cm 8"x8"	16	DECORO VALLAURIS PAVONCELLE (B228-B229-B157-B165-B227) VALLAURIS BIANCO	pz € 35,00	13				
 20x20 cm 8"x8"	16	DECORO VALLAURIS PESCI (B29-B30-B27-B32) VALLAURIS BIANCO	pz € 35,00	13				
 20x20 cm 8"x8"	16	DESIGN ITALIANO BIANCO S/10 MIX (VENDUTI A SCATOLE COMPLETE)	pz € 34,00	10				

FORMATO NOMINALE Nominal Size Format Nominal Nennformat	SPESSORE Thickness Epaisseur Stärke mm	ARTICOLO Item Article Artikel	1° SCELTA PREZZO SFUSO 1 st Choice loose price 1 Choix prix en vrac 1 wahl preis lose €.mq	BOX			PALLET		
				PEZZI Pieces Pièces Stücke	MQ Sqm Mc Qm	KG	SCATOLE Boxes Boîtes Kartons	MQ Sqm Mc Qm	KG

COTTI FATTI A MANO - HANDMADE COTTO







DECORI - DECORS - DÉCORS - DEKORE

	16	ELICRISIO S/1 (DECORATI A MANO) COTTO, NERO	pz € 68,00	6					
	16	ELICRISIO S/1 (DECORATI A MANO) COTTO, NERO	pz € 48,00	6					
	16	ELICRISIO S/2 (DECORATI A MANO) COTTO, NERO	pz € 27,00	6					
	16	LISTELLO ELICRISIO S/2 (DECORATI A MANO) COTTO, NERO	pz € 48,00	6					



LAVELLI

		LAVELLO PEPITE ROTONDO** (D'APPOGGIO) (PER GLI ABBINAMENTI, VEDI ARTICOLI PEPITE) IMBALLO SPECIALE CON ADDEBITO DI € 15,00	pz € 1.000,00	1		13,70			
		LAVELLO PEPITE OVALE** (D'APPOGGIO) (PER GLI ABBINAMENTI, VEDI ARTICOLI PEPITE) IMBALLO SPECIALE CON ADDEBITO DI € 17,00	pz € 1.050,00	1		15,50			

** LAVELLI SPECIALI REALIZZATI A MANO SOLO SU ORDINAZIONE. IMBALLO SPECIALE CON ADDEBITO DI € 15,00 PER IL LAVELLO ROTONDO E € 17,00 PER QUELLO OVALE.
REALIZZABILE SIA MONOCOLORE CHE MIX.
CUSTOM HANDE MADE BATHROOM SINK AVAILABLE FOR SPECIAL ORDER ONLY. EXTRA CHARGE OF € 15,00 FOR SPECIAL PACKAGING OF THE ROUND SINK AND € 17,00 FOR THE OVAL SINK.
AVAILABLE IN MONOCOLOR OR MIX.
ÉVIERS SPÉCIAUX FAITS MAIN, SUR COMMANDE UNIQUEMENT. EMBALLAGE SPÉCIAL FACTURÉ 15,00 € POUR L'ÉVIER ROND ET 17,00 € POUR CELUI OVALE. COLORATION
UNIQUE OU MIXTE POSSIBLE.
SPEZIALWASCHTISCHE, NUR AUF BESTELLUNG HANDGEFERTIGT. SPEZIALVERPACKUNG MIT BERECHNUNG VON € 15,00 FÜR DEN RUNDEN WASCHTISCH UND € 17,00
FÜR DEN OVALEN WASCHTISCH. SOWOHL EINFARBIG ALS AUCH GEMISCHT HERSTELLBAR.

FORMATO NOMINALE Nominal Size Format Nominal Nennformat	SPESSORE Thickness Epaisseur Stärke mm	ARTICOLO Item Article Artikel	1° SCELTA PREZZO SFUSO 1 st Choice loose price 1 Choix prix en vrac 1 wahl preis lose €.mq	BOX			PALLET		
				PEZZI Pieces Pièces Stücke	MQ Sqm Mc Qm	KG	SCATOLE Boxes Boîtes Kartons	MQ Sqm Mc Qm	KG
DECORI FATTI A MANO - HANDMADE DECORS									
 20x40 cm 8"x16"	10	DECORO DAMA 1 COMP. 2 PZ 20x20 (DECORATI A MANO) BLU, BORDEAUX, GIALLO, VERDE	comp € 50,00	comp 1					
 20x40 cm 8"x16"	10	DECORO DAMA 2 COMP. 2 PZ 20x20 (DECORATI A MANO) BLU, BORDEAUX, GIALLO, VERDE	comp € 50,00	comp 1					
 20x40 cm 8"x16"	10	DECORO DAMA 3 COMP. 2 PZ 20x20 (DECORATI A MANO) BLU, BORDEAUX, GIALLO, VERDE	comp € 50,00	comp 1					
 20x40 cm 8"x16"	10	DECORO CAVALIERE 1 COMP. 2 PZ 20x20 (DECORATI A MANO) BLU, BORDEAUX, GIALLO, VERDE	comp € 50,00	comp 1					
 20x40 cm 8"x16"	10	DECORO CAVALIERE 2 COMP. 2 PZ 20x20 (DECORATI A MANO) BLU, BORDEAUX, GIALLO, VERDE	comp € 50,00	comp 1					
 20x40 cm 8"x16"	10	DECORO CAVALIERE 3 COMP. 2 PZ 20x20 (DECORATI A MANO) BLU, BORDEAUX, GIALLO, VERDE	comp € 50,00	comp 1					
 20x20 cm 8"x8"	10	DECORO PINTADERA S/4 (DECORATI A MANO) BLU, BORDEAUX, GIALLO, VERDE	pz € 16,00	8					

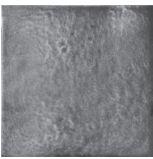
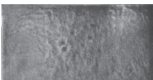
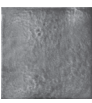

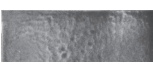
FORMATO NOMINALE Nominal Size Format Nominal Nennformat	SPESORE Thickness Epaisseur Stärke mm	ARTICOLO Item Article Artikel	1° SCELTA PREZZO SFUSO 1 st Choice loose price 1 Choix prix en vrac 1 wahl preis lose €.mq	BOX			PALLET		
				PEZZI Pieces Pièces Stücke	MQ Sqm Mc Qm	KG	SCATOLE Boxes Boîtes Kartons	MQ Sqm Mc Qm	KG
BICOTTURA IN PASTA ROSSA - RED BODY DOUBLE-FIRED TILES									
40x40 cm 16"x16" 	10	AZZURRO GHIACCIO MENTA NERO OCEANO PAVONE PRUGNA SENAPE	mq € 90,00	8	1,28	23,00	44	56,32	1.028
20x40 cm 8"x16" 	10	AZZURRO GHIACCIO MENTA NERO OCEANO PAVONE PRUGNA SENAPE	mq € 90,00	12	0,96	17,20	54	51,84	945
20x20 cm 8"x8" 	10	AZZURRO GHIACCIO MENTA NERO OCEANO PAVONE PRUGNA SENAPE	mq € 90,00	24	0,96	17,20	51	48,96	894
10x10 cm 4"x4" 	10	AZZURRO GHIACCIO MENTA NERO OCEANO PAVONE PRUGNA SENAPE	mq € 92,00	48	0,48	8,60	80	38,40	704
10x30 cm 4"x12" 	10	AZZURRO GHIACCIO MENTA NERO OCEANO PAVONE PRUGNA SENAPE	mq € 94,00	24	0,72	13,00	55	39,60	731

MOSAICI - MOSAICS - MOSAÏQUES - MOSAIKEN









29,2x30 cm 11 ⁷ / ₁₆ "x12" 	10	MOSAICO VENTAGLIO <i>SERIE COMPLETA</i> (SU FOGLI DI RETE IN FIBRA)	fg € 32,00	5	0,44	8,00			
24x24 cm 9 ⁷ / ₁₆ "x9 ⁷ / ₁₆ " 	10	MOSAICO LOSANGA <i>SERIE COMPLETA</i> (SU FOGLI DI RETE IN FIBRA)	fg € 24,00	5	0,29	5,00			
27,5x30 cm 10 ¹³ / ₁₆ "x12" 	10	MOSAICO BOVEDA <i>SERIE COMPLETA</i> (SU FOGLI DI RETE IN FIBRA)	fg € 29,00	5	0,42	7,50			



FORMATO NOMINALE Nominal Size Format Nominal Nennformat	SPESSORE Thickness Epaisseur Stärke mm	ARTICOLO Item Article Artikel	1° SCELTA PREZZO SFUSO 1 st Choice loose price 1 Choix prix en vrac 1 wahl preis lose €.mq	BOX			PALLET		
				PEZZI Pieces Pièces Stücke	MQ Sqm Mc Qm	KG	SCATOLE Boxes Boîtes Kartons	MQ Sqm Mc Qm	KG

BICOTTURA IN PASTA ROSSA - RED BODY DOUBLE-FIRED TILES

DECORI - DECORS - DÉCORS - DEKORE

 20x20 cm 8"x8"	10	LOGO MIX S/4 AZZURRO, GHIACCIO, MENTA, OCEANO PAVONE, PRUGNA, SENAPE	mq € 95,00	24	0,96	17,20	51	48,96	894
 20x20 cm 8"x8"	10	PALAU (su fondo ghiaccio) AZZURRO, MENTA, OCEANO, PAVONE, PRUGNA, SENAPE	mq € 250,00 pz € 16,00	24	0,96	17,20	51	48,96	894
 20x20 cm 8"x8"	10	PUNTALDIA (su fondo ghiaccio) AZZURRO, MENTA, OCEANO, PAVONE, PRUGNA, SENAPE	mq € 250,00 pz € 16,00	24	0,96	17,20	51	48,96	894
 20x20 cm 8"x8"	10	BUDONI (su fondo ghiaccio) AZZURRO, MENTA, OCEANO, PAVONE, PRUGNA, SENAPE	mq € 250,00 pz € 16,00	24	0,96	17,20	51	48,96	894
 20x20 cm 8"x8"	10	ARZACHENA (su fondo ghiaccio) AZZURRO, MENTA, OCEANO, PRUGNA	mq € 250,00 pz € 16,00	24	0,96	17,20	51	48,96	894
 20x20 cm 8"x8"	10	ISULEDDA (su fondo ghiaccio) AZZURRO, MENTA, OCEANO, PRUGNA	mq € 250,00 pz € 16,00	24	0,96	17,20	51	48,96	894
 20x20 cm 8"x8"	10	SAN PANTALEO MENTA, PAVONE, SENAPE	mq € 250,00 pz € 16,00	24	0,96	17,20	51	48,96	894
 20x20 cm 8"x8"	10	PORTO RAPHAEL MENTA, PAVONE, SENAPE	mq € 250,00 pz € 16,00	24	0,96	17,20	51	48,96	894
 20x20 cm 8"x8"	10	SANTA TERESA MENTA, PAVONE, SENAPE	mq € 250,00 pz € 16,00	24	0,96	17,20	51	48,96	894



FORMATO NOMINALE Nominal Size Format Nominal Nennformat	SPESSORE Thickness Epaisseur Stärke mm	ARTICOLO Item Article Artikel	1° SCELTA PREZZO SFUSO 1 st Choice loose price 1 Choix prix en vrac 1 wahl preis lose €.mq	BOX			PALLET		
				PEZZI Pieces Pièces Stücke	MQ Sqm Mc Qm	KG	SCATOLE Boxes Boîtes Kartons	MQ Sqm Mc Qm	KG

BICOTTURA IN PASTA ROSSA - RED BODY DOUBLE-FIRED TILES

DECORI - DECORS - DÉCORS - DEKORE

	10	GALLURA CLASSICO S/8	mq € 490,00 pz € 24,00	24 8	0,96	22,50	39	37,44	894
	10	GALLURA MODERNO S/8 BLU, VERDE	mq € 490,00 pz € 24,00	24 8	0,96	18,00	39	37,44	718
	10	MATITA METALLO SILVER	pz € 12,00	12					
	10	PRINCIPE S/4 BLU, VERDE	mq € 490,00 pz € 24,00	24 8	0,96	22,30	39	37,44	870
	10	MOSAICO PRINCIPE BLU, VERDE	fg € 54,00	5					

PEZZI SPECIALI - SPECIAL PIECES - PIÈCES SPECIALES - SPEZIALTEILE















		SERIE COMPLETA	pz € 15,00	24					
		SERIE COMPLETA	pz € 14,00	24					

LAVELLI

		LAVELLO SMALTATO ROTONDO* (D'APPOGGIO) <i>(MENTA, PAVONE, OCEANO, SENAPE, VERDE SCURO)</i> IMBALLO SPECIALE CON ADDEBITO DI € 15,00	pz € 600,00	1		6,00			
		LAVELLO SMALTATO ROTONDO CON ANELLO* (D'APPOGGIO) <i>(MENTA, PAVONE, OCEANO, SENAPE, VERDE SCURO)</i> IMBALLO SPECIALE CON ADDEBITO DI € 15,00	pz € 650,00	1		7,00			

* LAVELLI SPECIALI REALIZZATI A MANO SOLO SU ORDINAZIONE. IMBALLO SPECIALE CON ADDEBITO DI € 15,00 PER IL LAVELLO ROTONDO.
CUSTOM HAND MADE BATHROOM SINK AVAILABLE FOR SPECIAL ORDER ONLY. EXTRA CHARGE OF € 15,00 FOR SPECIAL PACKAGING OF THE ROUND SINK.
ÉVIERS SPÉCIAUX FAITS MAIN, SUR COMMANDE UNIQUEMENT. EMBALLAGE SPÉCIAL FACTURÉ 15,00 € POUR L'ÉVIER ROND.
SPEZIALWASCHTISCHE, NUR AUF BESTELLUNG HANDGEFERTIGT. SPEZIALVERPACKUNG MIT BERECHNUNG VON € 15,00 FÜR DEN RUNDEN WASCHTISCH.



FORMATO NOMINALE Nominal Size Format Nominal Nennformat	SPESORE Thickness Epaisseur Stärke mm	ARTICOLO Item Article Artikel	1° SCELTA PREZZO SFUSO 1 st Choice loose price 1 Choix prix en vrac 1 wahl preis lose €.mq	BOX			PALLET			
				PEZZI Pieces Pièces Stücke	MQ Sqm Mc Qm	KG	SCATOLE Boxes Boîtes Kartons	MQ Sqm Mc Qm	KG	
GRES FINE PORCELLANATO SMALTATO - GLAZED FINE PORCELAIN STONEWARE - GRÈS CÉRAME FIN ÉMAILLÉ - GLASIERTES FEINSTEINZEUG										
10x20 cm 4"x8" 	10	CENTRAL PLAZA CURCUMA CURRY DESERTO DEL NAMIB DOLOMIA EMPIRE STATE BUILDING	FELCE ARBOREA GRANITO ISOLA DI MAUI MANGROVIA ORTICA SALVIA	mq € 86,00	36	0,72	14,00	72	51,84	1.024
ESAGONA 15,8x18,3 cm 6 ¹ / ₄ "x7 ³ / ₁₆ " 	10	CENTRAL PLAZA CURCUMA CURRY DESERTO DEL NAMIB DOLOMIA EMPIRE STATE BUILDING	FELCE ARBOREA GRANITO ISOLA DI MAUI MANGROVIA ORTICA SALVIA	mq € 98,00	24	0,52	9,80	95	49,40	947
20x20 cm 8"x8" 	10	CENTRAL PLAZA (BIANCO) EMPIRE STATE BUILDING (NERO)		mq € 84,00	26	1,04	20,30	54	56,16	1.112
	10	MIX METROPOLI (34 SOGGETTI MIX*)		mq € 94,00	26	1,04	20,30	54	56,16	1.112
	10	MANHATTAN S/1		mq € 94,00	26	1,04	20,30	54	56,16	1.112
20x20 cm 8"x8" 	10	DOLOMIA (GRIGIO) GRANITO (TORTORA)		mq € 84,00	26	1,04	20,30	54	56,16	1.112
	10	MIX ROCCE (34 SOGGETTI MIX*)		mq € 94,00	26	1,04	20,30	54	56,16	1.112
	10	ROCCIA VULCANICA S/1		mq € 94,00	26	1,04	20,30	54	56,16	1.112
20x20 cm 8"x8" 	10	ORTICA (VERDE SCURO) SALVIA (VERDE CHIARO)		mq € 84,00	26	1,04	20,30	54	56,16	1.112
	10	MIX ERBE (34 SOGGETTI MIX*)		mq € 94,00	26	1,04	20,30	54	56,16	1.112
	10	ERBE DI PROVENZA S/1		mq € 94,00	26	1,04	20,30	54	56,16	1.112
20x20 cm 8"x8" 	10	CURCUMA (OCRA) CURRY (GIALLLO)		mq € 84,00	26	1,04	20,30	54	56,16	1.112
	10	MIX SPEZIE (34 SOGGETTI MIX*)		mq € 94,00	26	1,04	20,30	54	56,16	1.112
	10	SPEZIE INDIANE S/1		mq € 94,00	26	1,04	20,30	54	56,16	1.112

* SOGGETTI MISCELATI CASUALMENTE NELLE SCATOLE. DESIGNS AVAILABLE WITH EACH BOX CONTAINING A RANDOM MIX.
MOTIFS MÉLANGÉS AU HASARD DANS LES BOÎTES. DIE MUSTER IN DEN SCHACHTELN WERDEN NACH DEN ZUFALLSPRINZIP GEMISCHT.
IVA E TRASPORTO ESCLUSI, PALLET € 10,00, MINI PALLET € 7,00, PALLET BIG € 18,00/30,00 _ VAT AND TRASPORT NOT INCLUDED, PALLET € 10,00, MINI PALLET € 7,00, PALLET BIG € 18,00/30,00
TVA ET TRANSPORT NON INCLUS, PALLET € 10,00, MINI PALLET € 7,00, PALLET BIG € 18,00/30,00 _ MWST UND TRANSPORT NICHT INBEGRIFFEN, PALLET € 10,00, MINI PALLET € 7,00, PALLET BIG € 18,00/30,00





FORMATO NOMINALE Nominal Size Format Nominal Nennformat	SPESSORE Thickness Epaisseur Stärke mm	ARTICOLO Item Article Artikel	1° SCELTA PREZZO SFUSO 1 st Choice loose price 1 Choix prix en vrac 1 wahl preis lose €.mq	BOX			PALLET		
				PEZZI Pieces Pièces Stücke	MQ Sqm Mc Qm	KG	SCATOLE Boxes Boîtes Kartons	MQ Sqm Mc Qm	KG
GRES FINE PORCELLANATO SMALTATO - GLAZED FINE PORCELAIN STONEWARE - GRÈS CÉRAME FIN ÉMAILLÉ - GLASIERTES FEINSTEINZEUG									
20x20 cm 8"x8" 	10	FELCE ARBOREA (AZZURRO) MANGROVIA (PETROLIO)	mq € 84,00	26	1,04	20,30	54	56,16	1.112
	10	MIX FORESTA (34 SOGGETTI MIX*)	mq € 94,00	26	1,04	20,30	54	56,16	1.112
	10	FORESTA TROPICALE S/1	mq € 94,00	26	1,04	20,30	54	56,16	1.112
20x20 cm 8"x8" 	10	DESERTO DEL NAMIB (COTTO SCURO) ISOLA DI MAUI (COTTO CHIARO)	mq € 84,00	26	1,04	20,30	54	56,16	1.112
	10	MIX SABBIE (34 SOGGETTI MIX*)	mq € 94,00	26	1,04	20,30	54	56,16	1.112
	10	SABBIA DEL DESERTO S/1	mq € 94,00	26	1,04	20,30	54	56,16	1.112

LAVELLI





 ø 42 cm h 11,00 cm 16 ⁹ / ₁₆ " - 4 ⁵ / ₁₆ "	LAVELLO SMALTATO ROTONDO** (D'APPOGGIO) (MENTA, PAVONE, OCEANO, SENAPE, VERDE SCURO) IMBALLO SPECIALE CON ADDEBITO DI € 15,00	pz € 600,00	1	6,00				
 ø 42 cm h 15,50 cm 16 ⁹ / ₁₆ " - 6 ¹ / ₈ "	LAVELLO SMALTATO ROTONDO CON ANELLO** (D'APPOGGIO) (MENTA, PAVONE, OCEANO, SENAPE, VERDE SCURO) IMBALLO SPECIALE CON ADDEBITO DI € 15,00	pz € 650,00	1	7,00				

* SOGGETTI MISCELATI CASUALMENTE NELLE SCATOLE. DESIGNS AVAILABLE WITH EACH BOX CONTAINING A RANDOM MIX.
MOTIFS MÉLANGÉS AU HASARD DANS LES BOÎTES. DIE MUSTER IN DEN SCHACHTELN WERDEN NACH DEN ZUFALLSPRINZIP GEMISCHT.

** LAVELLI SPECIALI REALIZZATI A MANO SOLO SU ORDINAZIONE. IMBALLO SPECIALE CON ADDEBITO DI € 15,00 PER IL LAVELLO ROTONDO.
CUSTOM HANDE MADE BATHROOM SINK AVAILABLE FOR SPECIAL ORDER ONLY. EXTRA CHARGE OF € 15,00 FOR SPECIAL PACKAGING OF THE ROUND SINK.
ÉVIERS SPÉCIAUX FAITS MAIN, SUR COMMANDE UNIQUEMENT. EMBALLAGE SPÉCIAL FACTURÉ 15,00 € POUR L'ÉVIER ROND.
SPEZIALWASCHTISCHE, NUR AUF BESTELLUNG HANDGEFERTIGT. SPEZIALVERPACKUNG MIT BERECHNUNG VON € 15,00 FÜR DEN RUNDEN WASCHTISCH.

FORMATO NOMINALE Nominal Size Format Nominal Nennformat	SPESSORE Thickness Epaisseur Stärke mm	ARTICOLO Item Article Artikel	1° SCELTA PREZZO SFUSO 1 st Choice loose price 1 Choix prix en vrac 1 wahl preis lose €.mq	BOX			PALLET		
				PEZZI Pieces Pièces Stücke	MQ Sqm Mc Qm	KG	SCATOLE Boxes Boîtes Kartons	MQ Sqm Mc Qm	KG
BICOTTURA IN PASTA ROSSA - RED BODY DOUBLE-FIRED TILES									
20x40 cm 8"x16" 	10	ACQUA AMETISTA CRISTALLO GIADA PERLA PIETRA DI LUNA ZAFFIRO	mq € 96,00	12	0,96	17,20	54	51,84	945
20x20 cm 8"x8" 	10	ACQUA AMETISTA CRISTALLO GIADA PERLA PIETRA DI LUNA ZAFFIRO	mq € 88,00	24	0,96	16,70	51	48,96	870
10x10 cm 4"x4" 	10	ACQUA AMETISTA CRISTALLO GIADA PERLA PIETRA DI LUNA ZAFFIRO	mq € 90,00	48	0,48	8,40	80	38,40	690

MOSAICI - MOSAICS - MOSAÏQUES - MOSAIKEN

20x20 cm 8"x8" 3x3 cm 1 ¹³ / ₁₆ "x1 ¹³ / ₁₆ " 	10	MOSAICO TESSERA TRASPARENZE LILLA MIX (CRISTALLO, PERLA, AMETISTA) MOSAICO TESSERA TRASPARENZE TURCHESE MIX (CRISTALLO, PIETRA DI LUNA, ZAFFIRO) MOSAICO TESSERA TRASPARENZE VERDE MIX (ACQUA, CRISTALLO, GIADA) MOSAICO TESSERA TRASPARENZE MIX MULTICOLOR (SU FOGLI DI RETE IN FIBRA)	fg € 18,00	10	0,40	5,00			
26x26,5 cm 10 ¹ / ₄ "x10 ⁷ / ₁₆ " 	10	MOSAICO TRASPARENZE VENTAGLIO SERIE COMPLETA	fg € 34,00	5	0,34	6,00			
6,5x3,2 cm 2 ⁹ / ₁₆ "x1 ¹ / ₄ " 	10	CHIUSURA VENTAGLIO ORIZZONTALE SERIE COMPLETA	pz € 2,50	20					
3,2x6,5 cm 1 ¹ / ₄ "x2 ⁹ / ₁₆ " 	10	CHIUSURA VENTAGLIO VERTICALE DX-SX SERIE COMPLETA (SU FOGLI DI RETE IN FIBRA)	pz € 2,50	20					

FORMATO NOMINALE Nominal Size Format Nominal Nennformat	SPESSORE Thickness Epaisseur Stärke mm	ARTICOLO Item Article Artikel	1° SCELTA PREZZO SFUSO 1 st Choice loose price 1 Choix prix en vrac 1 wahl preis lose €.mq	BOX			PALLET		
				PEZZI Pieces Pièces Stücke	MQ Sqm Mc Qm	KG	SCATOLE Boxes Boîtes Kartons	MQ Sqm Mc Qm	KG

BICOTTURA IN PASTA ROSSA - RED BODY DOUBLE-FIRED TILES

MOSAICI - MOSAICS - MOSAÏQUES - MOSAIKEN

 30x30 cm 12"x12"	10	MOSAICO TRASPARENZE SPACCATELLA TURCHESE MIX (CRISTALLO, PIETRA DI LUNA, ZAFFIRO)	fg € 27,00	5	0,45	5,50			
		MOSAICO TRASPARENZE SPACCATELLA VERDE MIX (ACQUA, CRISTALLO, GIADA) (SU FOGLI DI RETE IN FIBRA)							

FASCE

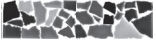
 10x40 cm 4"x16"	10	FASCIA SPACCATELLA MIX TURCHESE (CRISTALLO, PIETRA DI LUNA, ZAFFIRO) VERDE (ACQUA, CRISTALLO, GIADA) (SU FOGLI DI RETE IN FIBRA)	pz € 23,00	10					
---	----	--	---------------	----	--	--	--	--	--

LAVELLI

 ø 46,5 cm h 15,50 cm 18 ⁵ / ₁₆ " - 6 ¹ / ₈ "		LAVELLO SPACCATELLA ROTONDO* (D'APPOGGIO) (PER GLI ABBINAMENTI, VEDI ARTICOLI MOSAICO SPACCATELLA) IMBALLO SPECIALE CON ADDEBITO DI € 15,00	pz € 950,00	1		12,00			
 l 59,50 cm p 46,50 cm h 15,50 cm 23 ⁷ / ₁₆ " - 18 ⁵ / ₁₆ " - 6 ¹ / ₈ "		LAVELLO SPACCATELLA OVALE* (D'APPOGGIO) (PER GLI ABBINAMENTI, VEDI ARTICOLI MOSAICO SPACCATELLA) IMBALLO SPECIALE CON ADDEBITO DI € 17,00	pz € 980,00	1		13,00			

PEZZI SPECIALI - SPECIAL PIECES - PIÈCES SPECIALES - SPEZIALTEILE

SIGARO 3x20 cm 1 ¹³ / ₁₆ "x8"		AMETISTA, GIADA, ZAFFIRO	pz € 15,00	24					
PROFILO 1,2x20 cm 1/2"x8"		ACQUA, AMETISTA, CRISTALLO, GIADA, PERLA, PIETRA DI LUNA, ZAFFIRO	pz € 14,00	24					

DECORI - DECORS - DÉCORS - DEKORE

 10x10 cm 4"x4"	10	INSERTO FONDALE S/3 ACQUA, CRISTALLO, PIETRA DI LUNA	pz € 17,00	9					
--	----	--	---------------	---	--	--	--	--	--

* LAVELLI SPECIALI REALIZZATI A MANO SOLO SU ORDINAZIONE. IMBALLO SPECIALE CON ADDEBITO DI € 15,00 PER IL LAVELLO ROTONDO E € 17,00 PER QUELLO OVALE.
 REALIZZABILE SIA MONOCOLORE CHE MIX.
 CUSTOM HANDE MADE BATHROOM SINK AVAILABLE FOR SPECIAL ORDER ONLY. EXTRA CHARGE OF € 15,00 FOR SPECIAL PACKAGING OF THE ROUND SINK AND € 17,00 FOR THE OVAL SINK.
 AVAILABLE IN MONOCOLOR OR MIX.

FORMATO NOMINALE Nominal Size Format Nominal Nennformat	SPESSORE Thickness Epaisseur Stärke mm	ARTICOLO Item Article Artikel	1° SCELTA PREZZO SFUSO 1 st Choice loose price 1 Choix prix en vrac 1 wahl preis lose €.mq	BOX			PALLET			
				PEZZI Pieces Pièces Stücke	MQ Sqm Mc Qm	KG	SCATOLE Boxes Boîtes Kartons	MQ Sqm Mc Qm	KG	
GRES FINE PORCELLANATO SMALTATO - GLAZED FINE PORCELAIN STONEWARE - GRÈS CÉRAME FIN ÉMAILLÉ - GLASIERTES FEINSTEINZEUG										
20x20 cm 8"x8" 	11,5	ATLANTIC (BLU) BLU ALICE (TURCHESE) CENTOCCHIO (V. SCURO) CORBEZZOLO (ROSSO) ELICRISIO (COTTO) LINO (BEIGE)	MALACHITE (VERDE) MIRTO (AZZURRO) OPALE (ACQUA) PERGAMENA (BIANCO) QUERCIA (TORTORA)	mq € 92,00 mq € 100,00	21	0,84	20,90	51	42,84	1.085
OSSIDIANA MIX (SOGGETTI MIX*) 20x20 cm 8"x8" 	11,5	PERGAMENA BRONZO		mq € 102,00 mq € 106,00	21	0,84	20,90	51	42,84	1.085
QUADRELLA MIX (5 SOGGETTI MIX*) 20x20 cm 8"x8" 	11,5	ATLANTIC BLU ALICE CENTOCCHIO MALACHITE BRONZO	MIRTO OPALE PERGAMENA	mq € 102,00 mq € 106,00	21	0,84	20,90	51	42,84	1.085
20x40 cm 8"x16" 	11,5	ATLANTIC BLU ALICE CENTOCCHIO ELICRISIO LINO	MALACHITE MIRTO OPALE PERGAMENA QUERCIA	mq € 92,00	10	0,80	20,00	54	43,20	1.100
40x40 cm 16"x16" 	11,5	ATLANTIC BLU ALICE CENTOCCHIO ELICRISIO LINO	MALACHITE MIRTO OPALE PERGAMENA QUERCIA	mq € 92,00	7	1,12	26,50	44	49,28	1.185
40x60,8 cm 16"x24" 	11,5	ATLANTIC BLU ALICE CENTOCCHIO ELICRISIO LINO	MALACHITE MIRTO OPALE PERGAMENA QUERCIA	mq € 96,00	4	0,97	24,00	60	58,20	1.456

MOSAICI - MOSAICS - MOSAÏQUES - MOSAIKEN

30x30 cm 12"x12" 1x1 cm 7/16"x7/16" 	11,5	MOSAICO SPACCO <i>ATLANTIC, BLU ALICE, MALACHITE, OPALE, PERGAMENA</i> <i>BRONZO, SILVER</i> <i>(SU FOGLI DI RETE IN FIBRA)</i>	fg € 42,00 fg € 46,00	5	0,45	6,00				
30x30 cm 12"x12" 2,2x2,2 cm 7/8"x7/8" 	11,5	MOSAICO TESSERA <i>ATLANTIC, BLU ALICE, CENTOCCHIO, CORBEZZOLO, ELICRISIO, MALACHITE, MIRTO, OPALE, PERGAMENA, QUERCIA</i> <i>(SU FOGLI DI RETE IN FIBRA)</i>	fg € 30,00	5	0,45	6,00				

* SOGGETTI MISCELATI CASUALMENTE NELLE SCATOLE. DESIGNS AVAILABLE WITH EACH BOX CONTAINING A RANDOM MIX.
MOTIFS MÉLANGÉS AU HASARD DANS LES BOÎTES. DIE MUSTER IN DEN SCHACHTELN WERDEN NACH DEN ZUFALLSPRINZIP GEMISCHT.



IVA E TRASPORTO ESCLUSI, PALLET € 10,00, MINI PALLET € 7,00, PALLET BIG € 18,00/30,00 _ VAT AND TRASPORT NOT INCLUDED, PALLET € 10,00, MINI PALLET € 7,00, PALLET BIG € 18,00/30,00
TVA ET TRANSPORT NON INCLUS, PALLET € 10,00, MINI PALLET € 7,00, PALLET BIG € 18,00/30,00 _ MWST UND TRANSPORT NICHT INBEGRIFFEN, PALLET € 10,00, MINI PALLET € 7,00, PALLET BIG € 18,00/30,00



FORMATO NOMINALE Nominal Size Format Nominal Nennformat	SPESSORE Thickness Epaisseur Stärke mm	ARTICOLO Item Article Artikel	1° SCELTA PREZZO SFUSO 1 st Choice loose price 1 Choix prix en vrac 1 wahl preis lose €mq	BOX			PALLET		
				PEZZI Pieces Pièces Stücke	MQ Sqm Mc Qm	KG	SCATOLE Boxes Boîtes Kartons	MQ Sqm Mc Qm	KG

GRES FINE PORCELLANATO SMALTATO - GLAZED FINE PORCELAIN STONEWARE - GRÈS CÉRAME FIN ÉMAILLÉ - GLASIERTES FEINSTEINZEUG

DECORI - DECORS - DÉCORS - DEKORE

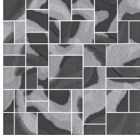
 20x20 cm 8"x8"	10	QUADRELLA MIX S/5 CIELO, MARE	mq € 470,00 pz € 23,00	21	0,84	20,90	51	42,84	1.085
 20x20 cm 8"x8"	10	GALLURA CLASSICO S/8	mq € 490,00 pz € 24,00	24	0,96	22,50	39	37,44	894
 20x20 cm 8"x8"	10	GALLURA MODERNO S/8 BLU, VERDE	mq € 490,00 pz € 24,00	24	0,96	18,00	39	37,44	718
2x20 cm 13/16"x8"	10	MATITA METALLO SILVER	pz € 12,00	12					
 20x20 cm 8"x8"	10	PRINCIPE S/4 BLU, VERDE	mq € 490,00 pz € 24,00	24	0,96	22,30	39	37,44	870
 30x30 cm 12"x12"	10	MOSAICO PRINCIPE BLU, VERDE	fg € 54,00	5					

PEZZI SPECIALI - SPECIAL PIECES - PIÈCES SPECIALES - SPEZIALTEILE







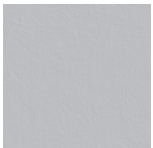

BATTISCOPA 6,5x40 cm 2 ⁹ / ₁₆ "x16"	11,5	ATLANTIC, BLU ALICE, CENTOCCHIO, ELICRISIO, MALACHITE, MIRTO, OPALE, PERGAMENA, QUERCIA	ml € 23,00	20	ml 8,00	13,00			
SIGARO 3x20 cm 1" ¹³ / ₁₆ "x8"		ATLANTIC, CENTOCCHIO, MALACHITE,	pz € 15,00	24					

LAVELLI





 ø 42 cm h 11,00 cm 16 ⁹ / ₁₆ " - 4 ⁵ / ₁₆ "		LAVELLO SMALTATO ROTONDO* (D'APPOGGIO) (MENTA, PAVONE, OCEANO, SENAPE, VERDE SCURO) IMBALLO SPECIALE CON ADDEBITO DI € 15,00	pz € 600,00	1		6,00			
 ø 42 cm h 15,50 cm 16 ⁹ / ₁₆ " - 6 ¹ / ₈ "		LAVELLO SMALTATO ROTONDO CON ANELLO* (D'APPOGGIO) (MENTA, PAVONE, OCEANO, SENAPE, VERDE SCURO) IMBALLO SPECIALE CON ADDEBITO DI € 15,00	pz € 650,00	1		7,00			

* LAVELLI SPECIALI REALIZZATI A MANO SOLO SU ORDINAZIONE. IMBALLO SPECIALE CON ADDEBITO DI € 15,00 PER IL LAVELLO ROTONDO.
CUSTOM HAND MADE BATHROOM SINK AVAILABLE FOR SPECIAL ORDER ONLY. EXTRA CHARGE OF € 15,00 FOR SPECIAL PACKAGING OF THE ROUND SINK.
ÉVIERS SPÉCIAUX FAITS MAIN, SUR COMMANDE UNIQUEMENT. EMBALLAGE SPÉCIAL FACTURÉ 15,00 € POUR L'ÉVIER ROND.
SPEZIALWASCHTISCHE, NUR AUF BESTELLUNG HANDGEFERTIGT. SPEZIALVERPACKUNG MIT BERECHNUNG VON € 15,00 FÜR DEN RUNDEN WASCHTISCH.



FORMATO NOMINALE Nominal Size Format Nominal Nennformat	SPESSORE Thickness Epaisseur Stärke mm	ARTICOLO Item Article Artikel		1° SCELTA PREZZO SFUSO 1 st Choice loose price 1 Choix prix en vrac 1 wahl preis lose €.mq	BOX			PALLET		
					PEZZI Pieces Pièces Stücke	MQ Sqm Mc Qm	KG	SCATOLE Boxes Boîtes Kartons	MQ Sqm Mc Qm	KG
GRES PORCELLANATO RETTIFICATO - PORCELAIN STONEWARE - RECTIFIED										
80x80 cm 32"x32" RETT 	10	ARGILLA BIANCO CARBONE GENZIANA GRAFITE OLEASTRO		mq € 100,00	2	1,28	29,00	40	51,20	1.180
RODO 80x80 cm 32"x32" RETT 	10	BIANCO RODO CARBONE RODO CORBEZZOLO RODO GENZIANA RODO	GRAFITE RODO MANGANESE RODO MIRTILLO RODO OLEASTRO RODO	mq € 108,00	2	1,28	29,00	40	51,20	1.180
40x80 cm 16"x32" RETT 	10	ARGILLA BIANCO CARBONE CORBEZZOLO GENZIANA	GRAFITE OLEASTRO	mq € 100,00	3	0,96	21,80	28	26,88	630
RODO MIX 40x80 cm 16"x32" RETT 	10	BIANCO RODO CARBONE RODO CORBEZZOLO RODO GENZIANA RODO	GRAFITE RODO MANGANESE RODO MIRTILLO RODO OLEASTRO RODO	mq € 108,00	3	0,96	21,80	28	26,88	630
20x80 cm 8"x32" RETT 	10	ARGILLA BIANCO CARBONE	CORBEZZOLO GRAFITE OLEASTRO	mq € 100,00	7	1,12	25,40	42	47,04	1.086
RODO MIX 20x80 cm 8"x32" RETT 	10	BIANCO RODO CARBONE RODO CORBEZZOLO RODO GENZIANA RODO	GRAFITE RODO MANGANESE RODO MIRTILLO RODO OLEASTRO RODO	mq € 108,00	7	1,12	25,40	42	47,04	1.086
6,5x40 cm 2 ⁹ / ₁₆ "x16" RETT 	10	CARBONE CORBEZZOLO GENZIANA	GRAFITE MANGANESE OLEASTRO	mq € 125,00	32	0,83	18,80	48	26,56	920
6,5x6,5 cm 2 ⁹ / ₁₆ "x2 ⁹ / ₁₆ " (su rete 20x20) RETT 	10	ARGILLA BIANCO CARBONE GENZIANA GRAFITE	MANGANESE MIRTILLO OLEASTRO	mq € 170,00 pz € 9,00	9	0,36	8,20	45	16,20	385



FORMATO NOMINALE Nominal Size Format Nominal Nennformat	SPESSORE Thickness Epaisseur Stärke mm	ARTICOLO Item Article Artikel	1° SCELTA PREZZO SFUSO 1 st Choice loose price 1 Choix prix en vrac 1 wahl preis lose €.mq	BOX			PALLET			
				PEZZI Pieces Pièces Stücke	MQ Sqm Mc Qm	KG	SCATOLE Boxes Boîtes Kartons	MQ Sqm Mc Qm	KG	
BICOTTURA IN PASTA BIANCA - WHITE BODY DOUBLE-FIRED TILES										
20x20 cm 8"x8" 	10	ANTRACITE ARGILLA CAOLINO CARBONE CORBEZZOLO GENZIANA GIACINTO	GLICINE GRAFITE LICHENE MANGANESE MIRTILLO OLEASTRO SALVIA	mq € 84,00	24	0,96	16,70	51	48,96	870
TRACCE MIX 20x20 cm 8"x8" 	10	ANTRACITE TRACCE ARGILLA TRACCE CARBONE TRACCE CORBEZZOLO TRACCE GRAFITE TRACCE	MANGANESE TRACCE MIRTILLO TRACCE OLEASTRO TRACCE SABBIA TRACCE	mq € 94,00	24	0,96	16,70	51	48,96	870
6,5x20 cm 2 ⁹ / ₁₆ "x8" 	10	ANTRACITE ARGILLA CAOLINO CARBONE GENZIANA GLICINE GRAFITE	LICHENE MANGANESE MIRTILLO OLEASTRO SABBIA SALVIA	mq € 125,00	38	0,494	8,90	84	41,50	765
6,5x6,5 cm 2 ⁹ / ₁₆ "x2 ⁹ / ₁₆ " (su rete 20x20) 	10	ANTRACITE ARGILLA BIANCO CALCEDONIO CAOLINO CARBONE CORBEZZOLO GENZIANA	GRAFITE LICHENE MANGANESE MIRTILLO OLEASTRO SABBIA SALVIA	mq € 210,00 pz € 12,00	9	0,36	6,30	45	16,20	300



TINTE D'ACCENTO

FORMATO NOMINALE Nominal Size Format Nominal Nennformat	SPESSORE Thickness Epaisseur Stärke mm	ARTICOLO Item Article Artikel	1° SCELTA PREZZO SFUSO 1 st Choice loose price 1 Choix prix en vrac 1 wahl preis lose €.mq	BOX			PALLET			
				PEZZI Pieces Pièces Stücke	MQ Sqm Mc Qm	KG	SCATOLE Boxes Boîtes Kartons	MQ Sqm Mc Qm	KG	
GRES SMALTATO TAGLIO A SPACCO BURATTATO - GLAZED PORCELAIN MADE BY CUT AND TUMBLED										
6,5x6,5 cm 2 ⁹ / ₁₆ "x2 ⁹ / ₁₆ " 	12	ARANCIONE BIANCO BLU CELESTE INDACO	MANDARINO MIMOSA NERO VERDE	mq € 260,00 pz € 16,00	9	0,36	16,50	45	16,20	760
(su fogli di rete in fibra 20x20)										
3,2x3,2 cm 1 ¹ / ₄ "x1 ¹ / ₄ " 	12	ARANCIONE BIANCO BLU CELESTE INDACO	MANDARINO MIMOSA NERO VERDE	mq € 330,00 pz € 19,00	9	0,36	16,50	45	16,20	760
(su fogli di rete in fibra 20x20)										

FORMATO NOMINALE Nominal Size Format Nominal Nennformat	SPESSORE Thickness Epaisseur Stärke mm	ARTICOLO Item Article Artikel	1° SCELTA PREZZO SFUSO 1 st Choice loose price 1 Choix prix en vrac 1 wahl preis lose €.mq	BOX			PALLET		
				PEZZI Pieces Pièces Stücke	MQ Sqm Mc Qm	KG	SCATOLE Boxes Boîtes Kartons	MQ Sqm Mc Qm	KG
GRES PORCELLANATO SMALTATO - GLAZED PORCELAIN STONEWARE									
120x120 cm 48"x48" RETT 	9,5	SUGHERO NATURALE	mq € 100,00	1	1,44	31,00	40	57,60	1.300
60x120 cm 24"x48" RETT 	9,5	BALI NATURALE BALI VERDE SUGHERO NATURALE TIGRE	mq € 90,00	2	1,44	31,00	36	51,84	1.144
60x60 cm 24"x24" RETT 	9,5	SUGHERO NATURALE	mq € 70,00	3	1,08	24,50	32	34,56	800
20x120 cm 8"x48" RETT 	9,5	BALI NATURALE BALI VERDE SUGHERO NATURALE TIGRE	mq € 90,00	4	0,96	20,70	48	46,08	1.022
ESAGONA 15,8x18,3 cm 6 ¹ / ₄ "x7 ³ / ₁₆ " 	10	BALI NATURALE BALI VERDE SUGHERO NATURALE TIGRE	mq € 84,00	24	0,52	9,80	95	49,40	947

MOSAICI - MOSAICS - MOSAÏQUES - MOSAIKEN

32x32 cm 16"x16" 	9,5	MOSAICO CERCHI <i>BALI NATURALE, BALI VERDE, SUGHERO NATURALE</i> <i>(SU FOGLI DI RETE IN FIBRA)</i>	fg € 32,00	5	0,51	11,00			
30x30 cm 12"x12" 	9,5	MOSAICO LISTELLATO <i>BALI NATURALE, BALI VERDE, SUGHERO NATURALE</i> <i>(SU FOGLI DI RETE IN FIBRA)</i>	fg € 22,00	5	0,45	10,00			
30x30 cm 12"x12" 	9,5	MOSAICO CALANGIANUS <i>BALI NATURALE, BALI VERDE</i> <i>(SU FOGLI DI RETE IN FIBRA)</i>	fg € 28,00	5	0,45	10,00			









DECORI - DECORS - DÉCORS - DEKORE

20x120 cm 8"x48" RETT 	9,5	CALANGIANUS MIX <i>NATURALE, VERDE</i>	pz € 65,00	4					
4,8x60 cm 3"x24" RETT 	9,5	LISTELLO CALANGIANUS MIX <i>NATURALE, VERDE</i>	pz € 17,00	12					
4,8x60 cm 3"x24" RETT 	9,5	LISTELLO METALLO <i>BRONZO, NERO</i>	pz € 18,00	12					
4,8x60 cm 3"x24" RETT 	9,5	LISTELLO CRISTALLINE BIANCO	pz € 21,00	12					

PEZZI SPECIALI - SPECIAL PIECES - PIÈCES SPECIALES - SPEZIALTEILE

BATTISCOPA 6,5x60 cm 2 ³ / ₁₆ "x24" RETT 	9,5	<i>BALI NATURALE, BALI VERDE, SUGHERO NATURALE</i>	ml € 18,00	12	ml 7,20	11,00			
--	-----	--	-----------------------------	----	------------	-------	--	--	--



FORMATO NOMINALE Nominal Size Format Nominal Nennformat	SPESSORE Thickness Epaisseur Stärke mm	ARTICOLO Item Article Artikel	1° SCELTA PREZZO SFUSO 1 st Choice loose price 1 Choix prix en vrac 1 wahl preis lose €.mq	BOX			PALLET		
				PEZZI Pieces Pièces Stücke	MQ Sqm Mc Qm	KG	SCATOLE Boxes Boîtes Kartons	MQ Sqm Mc Qm	KG
GRES PORCELLANATO SMALTATO - GLAZED PORCELAIN STONEWARE									
120x120 cm 48"x48" RETT 	9,5	YACHT CLUB DORATO YACHT CLUB CASTANO YACHT CLUB MORO	mq € 107,00	1	1,44	31,00	40	57,60	1.300
120x120 cm 48"x48" RETT R11 	9,5	YACHT CLUB DORATO YACHT CLUB CASTANO YACHT CLUB MORO	mq € 109,00	1	1,44	31,00	40	57,60	1.300
60x120 cm 24"x48" RETT 	9,5	YACHT CLUB DORATO YACHT CLUB CASTANO YACHT CLUB MORO	mq € 90,00	2	1,44	31,00	36	51,84	1.144
60x120 cm 24"x48" RETT R11 	9,5	YACHT CLUB DORATO YACHT CLUB CASTANO YACHT CLUB MORO	mq € 92,00	2	1,44	31,00	36	51,84	1.144
60x120 cm 24"x48" LUX-RETT 	9,5	YACHT CLUB DORATO YACHT CLUB CASTANO	mq € 105,00	2	1,44	31,00	36	51,84	1.144
20x120 cm 8"x48" RETT 	9,5	YACHT CLUB DORATO YACHT CLUB CASTANO YACHT CLUB MORO	mq € 90,00	4	0,96	20,70	48	46,08	1.022
20x120 cm 8"x48" RETT R11 	9,5	YACHT CLUB DORATO YACHT CLUB CASTANO YACHT CLUB MORO	mq € 92,00	4	0,96	20,70	48	46,08	1.022
20x120 cm 8"x48" LUX-RETT 	9,5	YACHT CLUB DORATO YACHT CLUB CASTANO	mq € 105,00	4	0,96	20,70	48	46,08	1.022

modelli • models

misure e prezzi • sizes and prices

MODELLO ROMAZZINO

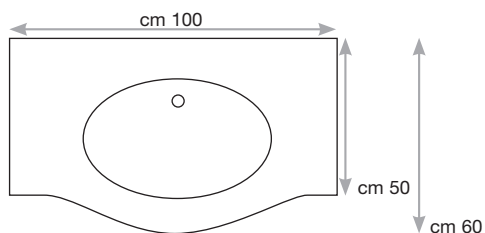

lavello incasso

cm 100x60x3,5	€ 672,00
3 bordi lav. semitono (3 rounded-edges)	€ 189,00
Fori lavabo/rubinetti (holes wash-basin/holes for taps)	€ 339,00

TOTALE/TOTAL € 1.200,00

lavello appoggio

cm 100x60x3,5	€ 672,00
3 bordi lav. semitono (3 rounded-edges)	€ 189,00
Fori lavabo/rubinetti (holes wash-basin/holes for taps)	€ 210,00

TOTALE/TOTAL € 1.071,00

MODELLO PITRIZZA DX/SX RIGHT/LEFT

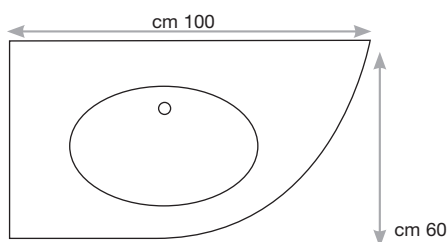

lavello incasso

cm 100x60x3,5	€ 672,00
2 bordi lav. semitono (2 rounded-edges)	€ 189,00
Fori lavabo/rubinetti (holes wash-basin/holes for taps)	€ 339,00

TOTALE/TOTAL € 1.200,00

lavello appoggio

cm 100x60x3,5	€ 672,00
2 bordi lav. semitono (2 rounded-edges)	€ 189,00
Fori lavabo/rubinetti (holes wash-basin/holes for taps)	€ 210,00

TOTALE/TOTAL € 1.071,00

MODELLO CALA DI VOLPE

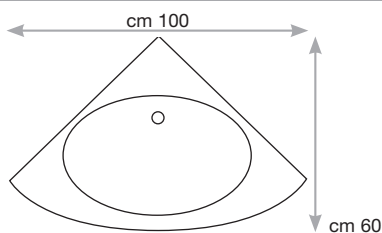

lavello incasso

cm 60x60x3,5	€ 672,00
1 bordo lav. semitono (1 rounded-edge)	€ 84,00
Fori lavabo/rubinetti (holes wash-basin/holes for taps)	€ 339,00

TOTALE/TOTAL € 1.095,00

lavello appoggio

cm 60x60x3,5	€ 672,00
1 bordo lav. semitono (1 rounded-edge)	€ 84,00
Fori lavabo/rubinetti (holes wash-basin/holes for taps)	€ 210,00

TOTALE/TOTAL € 966,00

MODELLO ROMAZZINO DOPPIO LAVABO DOUBLE WASH-BASIN

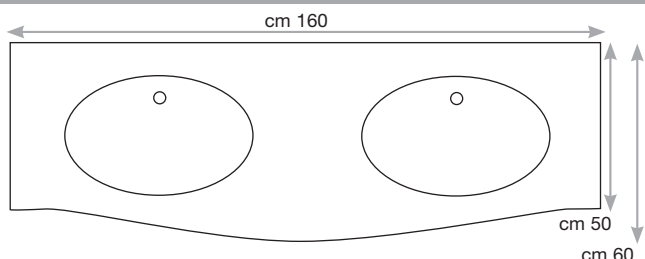

lavello incasso

cm 160x60x3,5	€ 1.075,00
3 bordi lav. semitono (3 rounded-edges)	€ 239,00
Fori lavabo/rubinetti (holes wash-basin/holes for taps)	€ 676,00

TOTALE/TOTAL € 1.990,00

lavello appoggio

cm 160x60x3,5	€ 1.075,00
3 bordi lav. semitono (3 rounded-edges)	€ 239,00
Fori lavabo/rubinetti (holes wash-basin/holes for taps)	€ 420,00

TOTALE/TOTAL € 1.734,00

MODELLO PITRIZZA DOPPIO LAVABO DX/SX RIGHT/LEFT - DOUBLE WASH-BASIN

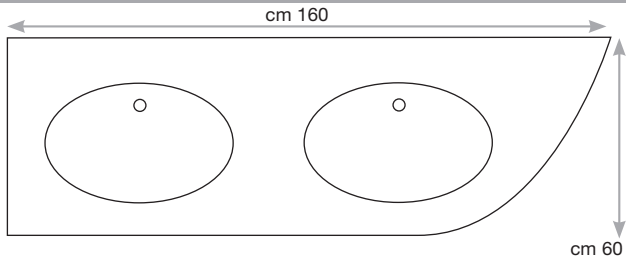

lavello incasso

cm 160x60x3,5	€ 1.075,00
2 bordi lav. semitono (2 rounded-edges)	€ 239,00
Fori lavabo/rubinetti (holes wash-basin/holes for taps)	€ 676,00

TOTALE/TOTAL € 1.990,00

lavello appoggio

cm 160x60x3,5	€ 1.075,00
2 bordi lav. semitono (2 rounded-edges)	€ 239,00
Fori lavabo/rubinetti (holes wash-basin/holes for taps)	€ 420,00

TOTALE/TOTAL € 1.734,00

MODELLO CALA DI LEPRE

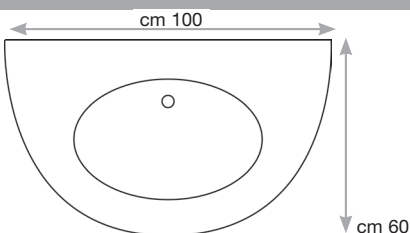

lavello incasso

cm 100x60x3,5	€ 672,00
1 bordo lav. semitono (1 rounded-edge)	€ 160,00
Fori lavabo/rubinetti (holes wash-basin/holes for taps)	€ 339,00

TOTALE/TOTAL € 1.171,00

lavello appoggio

cm 100x60x3,5	€ 672,00
1 bordo lav. semitono (1 rounded-edge)	€ 160,00
Fori lavabo/rubinetti (holes wash-basin/holes for taps)	€ 210,00

TOTALE/TOTAL € 1.042,00

MODELLI STANDARD - SPESSORE CM 3,5 • STANDARD MODELS - THICKNESS 1³/₈"

modelli • models

misure e prezzi • sizes and prices

MODELLO CASTELSARDO

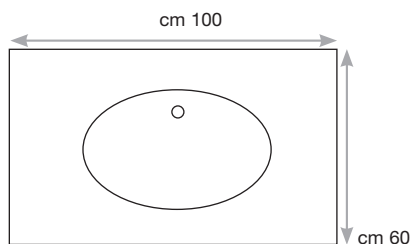

lavello incasso		lavello appoggio	
cm 100x60x3,5	€ 672,00	cm 100x60x3,5	€ 672,00
3 bordi lav. semitono (3 rounded-edges)	€ 189,00	3 bordi lav. semitono (3 rounded-edges)	€ 189,00
Fori lavabo/rubinetti (holes wash-basin/holes for taps)	€ 339,00	Fori lavabo/rubinetti (holes wash-basin/holes for taps)	€ 210,00
TOTALE/TOTAL	€ 1.200,00	TOTALE/TOTAL	€ 1.071,00

MODELLI STANDARD - SPESSORE CM 3,5 • STANDARD MODELS - THICKNESS 1³/₈"

modelli • models

misure e prezzi • sizes and prices

MODELLO QUADRATO

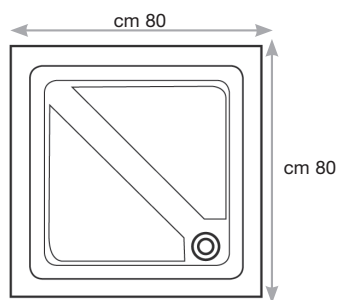

piatto doccia cm 80x80	€ 2.440,00
----------------------------------	------------

MODELLO RETTANGOLARE

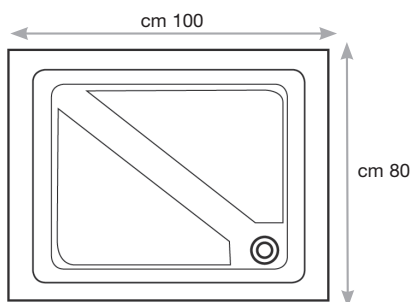

piatto doccia cm 100x80	€ 2.960,00
-----------------------------------	------------

MODELLO ANGOLARE

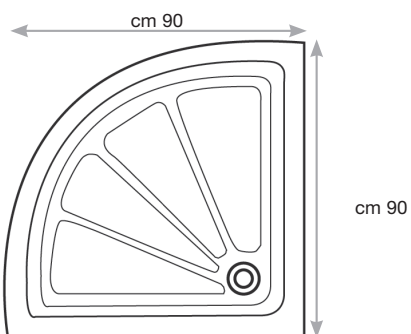

piatto doccia cm 90x90	€ 2.640,00
----------------------------------	------------

COLORI

ARANCIO, AZZURRO, BIANCO, BLU, GIADA, GIALLO, GRIGIO, LILLA, PERVINCA, ROSA, TURCHESE, VERDE ACQUA, VERDE SMERALDO.

MODELLI SU DISEGNO DEL CLIENTE

POSSONO ESSERE ORDINATI FINO A DIMENSIONI MASSIME DI CM 75x170, CON MAGGIORAZIONE DEL 20% SUL PREZZO BASE DELLA LAVA SMALTATA AL M²
(PREZZO BASE = € 1.120,00/M²). SI EFFETTUANO PREVENTIVI SU RICHIESTA DEL CLIENTE.

LAVORAZIONE E ACCESSORI

BORDO SEMITORO	€ 86,00/ML.
FORO LAVABO SOTTOPIANO (INCLUSI DA 1 A 3 FORI PER RUBINETTERIA)	€ 340,00/CAD.
FORO LAVABO SOPRAPIANO (INCLUSI DA 1 A 3 FORI PER RUBINETTERIA)	€ 210,00/CAD.
ALZATINA (H: CM 5; SPESSORE: CM 3,5) LAVORATA A BECCO DI CIVETTA	€ 150,00/ML.

MISURAZIONI

MINIMO FATTURABILE PER PIANI CON FORO LAVABO: M² 0,60. PER PIANI SAGOMATI SI CONSIDERA IL MASSIMO RETTANGOLO CIRCOSCRITTO (VUOTO PER PIENO).

IMBALLO

IN CASSE DI LEGNO CON ADDEBITO DI € 42,00/ML.

PREZZI

I PREZZI DEL PRESENTE LISTINO SONO NETTI DI I.V.A. E F/CO NS. DEPOSITO DI CASALGRANDE E OLBIA.

NOTE TECNICHE

PIANI IN LAVA VULCANICA DELL'ETNA, RICAVATI DA BLOCCHI OMOGENEI, SMALTATI CON CRISTALLINE CRAQUELÉ, PREDISPOSTI SUL ROVESCIO DI FORI CIECHI PER ANCORAGGIO DEI LAVABI SOTTOPIANO.

RESISTENZA MECCANICA ELEVATISSIMA, COMPATTEZZA MASSIMA. SOPPORTANO CARICHI CONCENTRATI FINO A KG 20/CM².

PESO: KG 110/M² CIRCA.

NON VERRANNO ACCETTATE CONTESTAZIONI PER DIFFERENZE DI TONALITÀ SIA NELLA STESSA PARTITA DI MATERIALE, SIA FRA QUESTA E I CAMPIONI DISPONIBILI (CHE, PER PRODOTTI ARTIGIANALI, HANNO LA SOLA FUNZIONE DI FORNIRE UN'INDICAZIONE DI MASSIMA), SIA FRA I PEZZI IN LAVA E LE NOSTRE PIASTRELLE CRAQUELÉ.

EVENTUALI PUNTINATURE, DIFFERENZE DI TONALITÀ E STONALIZZAZIONI, ANCHE MARCATE, FANNO PARTE DELLE CARATTERISTICHE DI QUESTO TIPO DI PRODOTTI, CHE SONO OTTENUTI SINGOLARMENTE ATTRAVERSO UNA LAVORAZIONE PEZZO PER PEZZO E SONO TECNOLOGICAMENTE DIVERSI, SIA COME SUPPORTO SIA COME SMALTO, DALLE NOSTRE PIASTRELLE, PER CUI NON POSSONO REPLICARNE L'ASPETTO E IL COLORE IN MODO IDENTICO.

LO STESSO DICASI PER IL CRAQUELÉ, TIPICO DI TUTTI I NOSTRI SMALTI, CHE SULLA LAVA, IN ALCUNI COLORI, RISULTA PIÙ MARCATO.

COLORS

ARANCIO, AZZURRO, BIANCO, BLU, GIADA, GIALLO, GRIGIO, LILLA, PERVINCA, ROSA, TURCHESE, VERDE ACQUA, VERDE SMERALDO.

CUSTOM MADE PIECES

WE CAN PRODUCE GLAZED LAVA TOPS ACCORDING TO THE CUSTOMER'S OWN DESIGN, ON DEMAND, PROVIDED THAT THE OVERALL DIMENSIONS DO NOT EXCEED 75x170.

THE PRICE WILL BE INCREASED BY 20% ON TOP OF THE STANDARD UNIT PRICE BEFORE INDICATED FOR A GLAZED SQUARE METER OF LAVA (BASIC PRICE = € 1.120,00/SQM).

SPECIAL EQUIPMENT AND HANDWORKING

ROUNDED-EDGE	€ 86,00/ML.
HOLE FOR WASH-BASIN UNDERTOP (INCLUDING 1 OR 3 HOLES FOR TAPS)	€ 340,00/CAD.
HOLE FOR WASH-BASIN OVERTOP (INCLUDING 1 OR 3 HOLES FOR TAPS)	€ 210,00/CAD.
LISTEL FOR THE BACK OF THE TOP WITH ROUNDED-EDGE (2" HIGH X 1"¼ THICKNESS)	€ 150,00/ML.

MEASUREMENTS

TOPS WITH HOLE FOR WASHBASIN WILL BE INVOICED FOR NO LESS THAN 0,60 SQUARE METERS. IN CASE OF VARIOUSLY SHAPED TOPS, THE MEASUREMENTS WILL TAKE INTO ACCOUNT THE MAXIMUM RECTANGLE THAT CAN BE DRAWN AROUND THE SHAPE.

PACKING

IN WOODEN CASES, CHARGED AT € 42,00/LFM

PRICES

THESE PRICES ARE EX-V.A.T. AND EX-OUR WAREHOUSE IN CASALGRANDE AND OLBIA.

TECHNICAL NOTES

TOPS IN ETNA VOLCANIC LAVA, MADE FROM UNIFORM BLOCKS FINISHED WITH CLEAR CRACKLE GLAZES, HAVING STOPPED HOLES ON THE REVERSE SIDE FOR MOUNTING UNDER-TOP WASHBASINS.

EXCEPTIONAL MECHANICAL STRENGTH, MAXIMUM COMPACTNESS. CAN SUPPORT LOADS OF UP TO 20 KG/CM².

WEIGHT: 110 KG/M² (APPROX.)

NO CLAIMS WILL BE ACCEPTED IN RELATION TO COLOUR DIFFERENCES, EITHER WITHIN THE SAME LOT OF MATERIAL OR BETWEEN THE SUPPLIED MATERIAL AND THE AVAILABLE SAMPLES (IN THE CASE OF ARTISANAL CERAMIC PRODUCTS, SAMPLE PIECES ARE TO BE CONSTRUED AS GUIDELINE), OR BETWEEN COMPONENTS MADE OF VOLCANIC LAVA STONE AND OUR CRACKLE EFFECT TILES.

ANY PINHOLING, TONAL DIFFERENCES AND VARIEGATED COLOURS, EVEN OF A SUBSTANTIAL NATURE, ARE AN INTRINSIC ASPECT OF THE CHARACTERISTICS OF PRODUCTS OF THIS TYPE, WHICH ARE MADE INDIVIDUALLY TILE BY TILE AND ARE THUS TECHNOLOGICALLY DIFFERENT - BOTH IN TERMS OF THE TILE BODY AND THE GLAZED SURFACE - FROM OUR CERAMIC TILES SO THEY CANNOT REPLICATE THE APPEARANCE AND COLOUR IN AN IDENTICAL MANNER.

THE SAME IS TRUE FOR THE CRACKLE EFFECT, WHICH IS TYPICAL OF ALL OUR GLAZES, WHICH MAY BE MORE EVIDENT ON LAVA STONE IN CERTAIN COLOURS.

LAVABI D'APPOGGIO

LAVELLO SPACCATELLA OVALE

lavello appoggio s/l ovale

dimensione: esterna 59,5x46,5xh15,50 cm*
 foro per scarico: ø 4 cm
 foro per top: ø 15 cm

TOTALE/TOTAL € 980,00
 IMBALLO € 17,00

Per gli abbinamenti, vedi articoli disponibili mosaico spaccatella, nelle serie Pitrezza e trasparenze Marine.

*Questo lavello è realizzato a mano, solo su ordinazione. Le misure indicate possono subire delle variazioni in ragione del ± 5%

LAVELLO PEPITE OVALE

lavello appoggio s/l ovale

dimensione: esterna 59,5 x 46,5 x h15,50 cm*
 foro per scarico: ø 4 cm
 foro per top: ø 15 cm

TOTALE/TOTAL € 1.050,00
 IMBALLO € 17,00

Per gli abbinamenti, vedi articoli disponibili del mosaico pepite, nelle serie I Cotti fatti a mano.

*Questo lavello è realizzato a mano, solo su ordinazione. Le misure indicate possono subire delle variazioni in ragione del ± 5%

LAVELLO SPACCATELLA ROTONDO

lavello appoggio s/l rotondo

dimensione: esterna ø 46,5 x h15,50 cm*
 foro per scarico: ø 4 cm
 foro per top: ø 15 cm

TOTALE/TOTAL € 950,00
 IMBALLO € 15,00

Per gli abbinamenti, vedi articoli disponibili mosaico spaccatella, nelle serie Pitrezza e trasparenze Marine.

*Questo lavello è realizzato a mano, solo su ordinazione. Le misure indicate possono subire delle variazioni in ragione del ± 5%

LAVELLO PEPITE ROTONDO

lavello appoggio s/l rotondo

dimensione: esterna ø 46,5 x h15,50 cm*
 foro per scarico: ø 4 cm
 foro per top: ø 15 cm

TOTALE/TOTAL € 1.000,00
 IMBALLO € 15,00

Per gli abbinamenti, vedi articoli disponibili del mosaico pepite, nelle serie I Cotti fatti a mano.

*Questo lavello è realizzato a mano, solo su ordinazione. Le misure indicate possono subire delle variazioni in ragione del ± 5%

LAVELLO SMALTATO ROTONDO

lavello appoggio smaltato rotondo

dimensione: esterna ø 42,00 x h11,00 cm*
 foro per scarico: ø 4 cm
 foro per top: ø 15 cm

TOTALE/TOTAL € 600,00
 IMBALLO € 15,00

Disponibile nei colori: Menta, Pavone, Oceano, Senape, Verde Scuro.

*Questo lavello è realizzato a mano, solo su ordinazione. Le misure indicate possono subire delle variazioni in ragione del ± 5%

LAVELLO SMALTATO ROTONDO CON ANELLO

lavello appoggio smaltato rotondo

dimensione: esterna ø 42,00 x h15,50 cm*
 foro per scarico: ø 4 cm
 foro per top: ø 15 cm

TOTALE/TOTAL € 650,00
 IMBALLO € 15,00

Disponibile nei colori: Menta, Pavone, Oceano, Senape, Verde Scuro.

*Questo lavello è realizzato a mano, solo su ordinazione. Le misure indicate possono subire delle variazioni in ragione del ± 5%

COLLEZIONI**(PITRIZZA/MAREZZATI, SARDINIA, TINTÙRI, TRASPARENZE MARINE, I COTTI FATTI A MANO, OT07026)****DIMENSIONI**

TRATTANDOSI DI MATERIALE REALIZZATO A MANO, LE DIMENSIONI NOMINALI RIPORTATE COME LUNGHEZZA, LARGHEZZA, SPESSORE E ORTOGONALITÀ SONO DA CONSIDERARE CORRETTE MA INDICATIVE.

DESTINAZIONI D'USO CONSIGLIATE

- PAVIMENTI E RIVESTIMENTI DI AMBIENTI RESIDENZIALI E COMMERCIALI INTERNI A BASSO TRAFFICO.
- LE FINITURE CON EFFETTO CRAQUELÉ SI CONSIGLIANO SOLO A RIVESTIMENTO DI INTERNI.
- PAVIMENTI PREESENTI (RISTRUTTURAZIONE DI VECCHI PAVIMENTI IN CERAMICA, MARMO, COTTO, PIETRA).
- MASSETTI PORTANTI IN CEMENTO ASCIUTTI.
- MASSETTI CON RISCALDAMENTO A PAVIMENTO, PAVIMENTI SOPRAELEVATI.
- PARETI INTERNE, SUPERFICI IN CARTONGESSO (PREVIA APPLICAZIONE SUL SUPPORTO DI UN PRIMER IDONEO).
- NON UTILIZZABILI PER IL RIVESTIMENTO DI: PAVIMENTAZIONI RIVESTITE IN MOQUETTES / PAVIMENTAZIONI RIVESTITE CON SUPERFICI COMPRI-MIBILI / PAVIMENTAZIONI E RIVESTIMENTI ESTERNI / VASCHE PISCINA / O PER ZONE A CONTATTO CONTINUO CON ACQUA CORRENTE.

INDICAZIONI PER LA POSA

- VERIFICARE LA CORRETTA PLANARITÀ DEL SUPPORTO ED EVENTUALMENTE LIVELLARE LA SUPERFICIE PRIMA DELLA POSA, TRATTANDOSI DI UN PRODOTTO ALTAMENTE ARTIGIANALE VERIFICARE CHE NON SIA PRESENTE UMIDITÀ RESIDUA PRIMA DELLA POSA (NEL CASO LASCIARLO ASCIUGARE COMPLETAMENTE), SCEGLIERE L'ADESIVO IN FUNZIONE DEL TIPO DI SUPPORTO E SEGUIRE LE ISTRUZIONI DI UTILIZZO INDICATE DAL PRODUTTORE.
- NON BAGNARE LE PIASTRELLE PRIMA O DURANTE LA POSA.
- TALI FINITURE POSSONO ESSERE APPLICATI CON L'UTILIZZO DI ADESIVI CEMENTIZI CLASSE C2 E, O ADESIVI REATTIVI CLASSE R2 (DA VERIFICARE A SECONDA DELLE CARATTERISTICHE DEL SUPPORTO).
- LA DIFFERENZA DI TONALITÀ FRA LE PIASTRELLE DI COLORE E TONO NON È DA CONSIDERARSI DIFETTO MA BENSÌ CARATTERISTICA DI MANUFATTI ALTAMENTE ARTIGIANALI. PERTANTO, NELLA POSA, SI SUGGERISCE DI ATTINGERE DA PIÙ SCATOLE CONTEMPORANEAMENTE PER OTTENERE UN MIGLIOR RISULTATO ESTETICO.
- PRIMA DI POSARE IL PRODOTTO, SI CONSIGLIA DI VERIFICARE LE CARATTERISTICHE DIMENSIONALI (SOPRATTUTTO SPESSORE, RETTILINEITÀ E PLANARITÀ), SEGUENDO SEMPRE LE NORME TECNICO-ESTETICHE PER UNA POSA ESEGUITA "A REGOLA D'ARTE".
- SI SUGGERISCE DI LASCIARE UNA FUGA MINIMA DI 2/3 MM, LO STUCCO DOVRÀ ESSERE DI NATURA CEMENTIZIA (SI SCONSIGLIANO STUCCHI REATTIVI) ASPORTATO RAPIDAMENTE DURANTE LE FASI DI APPLICAZIONI PER EVITARE EVENTUALI RESSIDUI.
- SI CONSIGLIA LA FUGA COLORATA TONO SU TONO IN ABBINAMENTO ALLA CROMIA DEL PRODOTTO, AL FINE DI ESALTARE L'EFFETTO ESTETICO FINALE, NON UTILIZZARE COLORAZIONI DI STUCCO A CONTRASTO.
- DOPO LE OPERAZIONI DI POSA / STUCCATURA E PULIZIA SI CONSIGLIA PER LA VERSIONE TERRA COTTA, DI ATTENDERE ALMENO UN PAIO DI GIORNI AFFINCHÉ AVVENGA LA COMPLETA ASCIUGATURA DELLA PAVIMENTAZIONE E SI POTRÀ PROCEDERE APPLICANDO SU TUTTA LA SUPERFICIE UN PRODOTTO A BASE DI CERA.
- SI CONSIGLIA DI PROTEGGERE LE SUPERFICI CON CARTONI SPESSI NELLE FASI DI SISTEMAZIONI ARREDI.

INDICAZIONI PER LA MANUTENZIONE STRAORDINARIA O FINE CANTIERE

PER IL LAVAGGIO E IL TRATTAMENTO DI FINE CANTIERE, SI AVVERTE DI NON UTILIZZARE DETERGENTI ACIDI. RIPULIRE LA SUPERFICIE EFFETTUANDO UN LAVAGGIO CON UNA SOLUZIONE ACQUOSA OTTENUTA DILUENDO DETERGENTI NEUTRI (TIPO FILACLEANER DI FILA). EFFETTUARE IL PRIMO PASSAGGIO UTILIZZANDO UNA SPUGNA O UN TAMPONE BIANCO PER POI RISCACQUARE CON ACQUA.

INDICAZIONI PER LA MANUTENZIONE ORDINARIA

EVITARE PRODOTTI DETERGENTI AGGRESSIVI E ABRASIVI (PRODOTTI ANTI-CALCARE, SPUGNE ABRASIVE, ECC.). SI CONSIGLIA L'IMPIEGO DI PRODOTTI A BASE NEUTRA NORMALMENTE REPERIBILI IN COMMERCIO. SI AVVERTE CHE METTERE A CONTATTO PIASTRELLE CERASARDA (DOTATE DI TEXTURE CRAQUELÉ) CON ACQUA, SOSTANZE E MATERIALI SPORCHI O UNTUOSI PUÒ ROVINARE L'EFFETTO CRAQUELÉ DELLA SUPERFICIE. PER LA VERSIONE TERRA COTTA, DOPO LA PULIZIA, SI CONSIGLIA DI APPLICARE UNA SOLUZIONE DI ACQUA E CERA. PER LA VERSIONE TERRA COTTA, POTREBBE COMUNQUE MANTENERE UN ASSORBIMENTO SUPERFICIALE, PERTANTO NEL CASO DI CADUTA DI LIQUIDI MACCHIANTI O AGGRESSIVI, ASPORTARE RAPIDAMENTE CON UNA SPUGNA INUMIDITA CON ACQUA.

AVVERTENZE:

IL PARTICOLARE SUPPORTO IN COTTO RICAVATO PER ESTRUSIONE PRESENTA UN ASSORBIMENTO ELEVATO. LO SMALTO UTILIZZATO IN TALI COLLEZIONI (ECCEPTE LA FINITURA COTTO SARDO), PUÒ PRESENTARE FESSURAZIONI SUPERFICIALI IDENTIFICABILI COME EFFETTO CRAQUELÉ, CARATTERISTICA DEI MANUFATTI DI ALTO ARTIGIANO DI NATURA CERAMICA.

TRATTAMENTO ANTI-MACCHIA

A SUPERFICIE ASCIUTTA, DISTRIBUIRE MEDIANTE PENNELLO UNA MANO DI PROTETTIVO ANTIMACCHIA PER SUPERFICI LUCIDE (TIPO MP/90 DI FILA). APPLICARE POCO PRODOTTO PRESTANDO ATTENZIONE AD UNIFORMARLO BENE. DOPO 4-6 ORE DALL'APPLICAZIONE DELL'IMPREGNANTE RIMUOVERE L'ECESSO CHE SI È FORMATO CON UN PANNINO ASCIUTTO O, AL MASSIMO, UMIDO.

MANUTENZIONE PERIODICA

PER SUPERFICI PARTICOLARMENTE ESPOSTE ALLE MACCHIE, COME RIVESTIMENTI E PIANI CUCINA, CONSIGLIAMO DI RINNOVARE OGNI 2-3 ANNI IL TRATTAMENTO ANTI-MACCHIA. PER EFFETTUARE TALE MANUTENZIONE CONSIGLIAMO DI PULIRE PRIMA LA SUPERFICIE CON PRODOTTI NEUTRI (TIPO FILACLEANER DI FILA). DOPO IL LAVAGGIO, A SUPERFICIE ASCIUTTA, DISTRIBUIRE PRODOTTI PROTETTIVI ANTIMACCHIA PER SUPERFICI LUCIDE (TIPO MP/90 DI FILA).

COLLECTIONS**(PITRIZZA/MAREZZATI, SARDINIA, TINTÙRI, TRASPARENZE MARINE, I COTTI FATTI A MANO, OT07026)****DIMENSIONS**

SINCE THESE ARE HAND CRAFTED TILES, THE NOMINAL LENGTH, WIDTH, THICKNESS AND RECTANGULARITY VALUES, ALTHOUGH ACCURATELY STATED, MUST BE CONSTRUED AS GUIDELINE.

RECOMMENDED APPLICATIONS

- FLOOR AND WALL SURFACES FOR RESIDENTIAL AND LOW-TRAFFIC COMMERCIAL INTERIORS.
- CRACKLE EFFECT FINISHES ARE RECOMMENDED EXCLUSIVELY FOR INTERIOR WALL SURFACES.
- EXISTING FLOOR SURFACES (REFURBISHMENT OF ORIGINAL CERAMIC, MARBLE, COTTO AND STONE FLOORS).
- DRY STRUCTURAL SCREEDS IN CEMENT.
- SCREEDS WITH UNDERFLOOR HEATING SYSTEMS, FLOATING FLOORS.
- INTERIOR WALLS, PLASTERBOARD SURFACES (AFTER APPLYING A SUITABLE PRIMER TO THE SUBSTRATE).
- NOT SUITABLE FOR INSTALLATION ON: FLOORS WITH FITTED CARPETS / OTHER COMPRESSIBLE COVERINGS / EXTERIOR FLOORS AND WALLS / SWIMMING POOLS / AREAS IN CONSTANT CONTACT WITH RUNNING WATER.

INSTALLATION INSTRUCTIONS

- CHECK THE FLATNESS OF THE SUBSTRATE AND LEVEL IT IF NECESSARY BEFORE PROCEEDING. SINCE THE TILES ARE HAND CRAFTED, CHECK FOR POSSIBLE TRACES OF RESIDUAL HUMIDITY BEFORE INSTALLING (IF NECESSARY, ALLOW THEM TO DRY COMPLETELY); SELECT THE ADHESIVE IN COMPLIANCE WITH THE SUBSTRATE AND FOLLOW THE MANUFACTURER'S DIRECTIONS FOR USE.
- DO NOT WET THE TILES BEFORE OR DURING INSTALLATION.
- THESE TILES CAN BE INSTALLED USING CLASS C2 E CEMENT ADHESIVES OR CLASS R2 REACTIVE ADHESIVES (TO BE CHECKED IN ACCORDANCE WITH THE CHARACTERISTICS OF THE SUBSTRATE).
- COLOUR AND TONAL DIFFERENCES BETWEEN INDIVIDUAL TILES ARE NOT TO BE VIEWED AS DEFECTS BUT RATHER AS AN INNATE CHARACTERISTIC OF HIGHLY ARTISANAL PRODUCTS. AT THE TIME OF INSTALLATION WE THEREFORE RECOMMEND MIXING TILES FROM DIFFERENT BOXES TO MAXIMISE THE AESTHETIC EFFECT OF THE FINISHED SURFACE.
- BEFORE INSTALLING THE TILES, CHECK THEIR DIMENSIONAL CHARACTERISTICS (ESPECIALLY THICKNESS, STRAIGHTNESS AND FLATNESS), FOLLOWING TECHNICAL-AESTHETIC BEST PRACTICES AT ALL TIMES TO ACHIEVE THE OPTIMAL RESULTS.
- WE RECOMMEND CREATING JOINTS OF AT LEAST 2 OR 3 MM. USE EXCLUSIVELY CEMENT-BASED GROUTS (REACTIVE GROUTS SHOULD BE AVOIDED) AND REMOVE SURPLUS MATERIAL RAPIDLY WHILE YOU WORK TO AVOID UNSIGHTLY RESIDUES.
- FOR THE MAXIMUM VISUAL APPEAL OF THE SURFACE CHOOSE A GROUT COLOUR THAT IS COORDINATED WITH THE TILE COLOUR, TAKING CARE TO AVOID CONTRASTING GROUT COLOURS.
- AFTER INSTALLATION / GROUTING AND CLEANING, FOR THE TERRACOTTA VERSION WE RECOMMEND WAITING AT LEAST TWO DAYS FOR THE FLOOR TO DRY COMPLETELY AND THEN APPLYING A WAX BASED PROTECTANT.
- WE RECOMMEND PROTECTING TILED SURFACES WITH HEAVY CARDBOARD WHEN INSTALLING FURNITURE AND FITTINGS.

INSTRUCTIONS FOR SPECIAL MAINTENANCE OR WORKSITE COMPLETION PROCEDURES

DO NOT USE ACID DETERGENTS FOR WASHING AND SURFACE TREATMENTS AT THE TIME OF WORKSITE COMPLETION, CLEAN THE SURFACE WITH A SOLUTION OF WATER AND NEUTRAL DETERGENT (SUCH AS FILA'S "FILACLEANER"). THE FIRST PASS SHOULD BE DONE WITH A SPONGE OR WHITE BUFFING PAD FOLLOWED BY A WATER RINSE.

ROUTINE MAINTENANCE INSTRUCTIONS

AVOID AGGRESSIVE AND ABRASIVE CLEANING PRODUCTS (SCALE REMOVER PRODUCTS, SCOURERS, ETC.). USE NORMAL COMMERCIALY AVAILABLE NEUTRAL CLEANING PRODUCTS. NOTE THAT ALLOWING CERASARDA TILES (WITH CRACKLE TEXTURED SURFACES) TO COME INTO CONTACT WITH DIRTY OR GREASY WATER, SUBSTANCES OR MATERIALS MAY CAUSE IRREVERSIBLE DAMAGE TO THE CRACKLE SURFACE. FOR THE TERRACOTTA VERSION WE RECOMMEND APPLYING A WATER AND WAX SOLUTION AFTER CLEANING THE SURFACE. THE SURFACE OF THE TERRACOTTA VERSION MAY REMAIN SOMEWHAT ABSORBENT SO ENSURE ANY SPILLS OF STAINING OR AGGRESSIVE LIQUIDS ARE MOPPED UP RAPIDLY WITH A SPONGE MOISTENED WITH WATER.

PRECAUTIONS:

THE SPECIAL EXTRUDED COTTO TILE BODY IS HIGHLY ABSORBENT. THE GLAZE EMPLOYED FOR THESE COLLECTIONS (WITH THE EXCEPTION OF THE SARDO COTTO FINISH) MAY DISPLAY SURFACE FISSURES COMMONLY KNOWN AS A CRACKLE EFFECT TEXTURE, THIS BEING A DISTINCTIVE FEATURE OF HIGHLY ARTISANAL CERAMIC PRODUCTS.

STAIN PROTECTION TREATMENT

WHEN THE SURFACE IS PERFECTLY DRY, BRUSH ON A COAT OF A STAIN PROTECTION SEALANT FOR GLOSSY SURFACES (SUCH AS FILA'S MP/90). APPLY A SMALL AMOUNT OF THE PRODUCT, TAKING CARE TO SPREAD IT EVENLY. FROM 4 TO 6 HOURS AFTER APPLYING THE SEALANT REMOVE SURPLUS PRODUCT WITH A DRY CLOTH OR, IF NECESSARY, A DAMP CLOTH.

PERIODIC MAINTENANCE

WE RECOMMEND REPEATING THE STAIN PROTECTION TREATMENT AT 2 OR 3-YEAR INTERVALS IN THE CASE OF SURFACES AT HIGH RISK OF STAINING, SUCH AS KITCHEN WALL SURFACES AND TOPS. BEFORE APPLYING THE TREATMENT THE SURFACE SHOULD BE CLEANED WITH A NEUTRAL CLEANING PRODUCT (SUCH AS FILA'S FILACLEANER). AFTER WASHING, ONCE THE SURFACE IS DRY APPLY A STAIN PROTECTION SEALANT FOR GLOSSY SURFACES (SUCH AS FILA'S MP/90).

- NORMATIVA CONTRATTUALE** – Le presenti condizioni generali, salvo eventuali modificazioni o deroghe concordate per iscritto, disciplinano tutti i contratti di vendita tra noi e l'acquirente, quindi tanto il contratto concluso con l'accettazione del presente ordine che qualsiasi contratto futuro relativo alle forniture dei prodotti della nostra società ordinati con successive e distinte commissioni.
 - FORNITURE** – Il prezzo qui specificato si intende al netto di spese di trasporto, IVA ed eventuali diritti di dogana; per merce resa franco ns. stabilimento.
 - ORDINI** – Il Committente si obbliga a mantenere ferma la proposta d'ordine rilasciata a personale commerciale della ns. società. Ogni ordine trasmesso dai ns. Agenti è sempre raccolto "SALVO APPROVAZIONE DELLA CASA", per cui ci riserviamo di non accettare o modificare l'ordine stesso. Quanto sopra vale anche per eventuali cessazioni gratuite per sala mostra. Prima di evadere gli ordini, l'azienda si riserva la facoltà di richiedere informazioni commerciali.
 - CONSEGNE** – I termini di consegna non sono mai impegnativi; comunque, il mancato espletamento dell'ordine se confermato o il ritardo nella sua esecuzione escludono ogni ns. responsabilità da cause a noi imputabili, quali impedimenti o difficoltà nei trasporti, scioperi, serrate, impossibilità o anche soltanto difficoltà di tempestivo approvvigionamento delle materie prime. Il committente, quindi, non può in nessun caso chiedere la risoluzione del contratto o esigere indennizzi da eventuali danni diretti o indiretti per il ritardo nella consegna.
 - SCELTE** – Il materiale verrà consegnato nelle scelte ordinate. Pertanto, le richieste di determinate percentuali di scelta verranno intese come semplici indicazioni e soddisfatte compatibilmente con le rese di produzione.
 - TRASPORTO** – La merce viaggia a rischio e pericolo del Committente anche se resa franco destino e la ns. responsabilità cessa con la consegna al vettore, per tanto, i reclami per eventuali ammanchi o rotture dovranno essere rivolti esclusivamente a questi.
 - PREZZI** – Ci riserviamo la facoltà di modificare i prezzi del presente listino con un preavviso di 30 (trenta) giorni.
 - PAGAMENTI** – I pagamenti devono pervenire presso la ns. sede. L'accettazione da parte ns. di effetti o assegni emessi fuori piazza o comunque il convenuto pagamento a mezzo tratte non deroga tale condizione. Le fatture non contestate entro 8 (otto) giorni dal ricevimento si intendono accettate. I pagamenti dovranno avvenire nei modi e nei termini pattuiti nella ns. commissione. In caso di ritardato pagamento di somme a noi dovute, è ns. facoltà sospendere le forniture e annullare i rapporti in corso. Gli interessi per ritardato pagamento dovranno essere convenuti espressamente con tassi da definire. In difetto verranno applicati gli interessi moratori di legge.
 - CONTESTAZIONE PER VIZI** – Eventuali contestazioni per vizi qualsiasi sia palesi sia occulti della merce oggetto della fornitura devono essere inoltrate alla ns. sede a mezzo raccomandata con avviso di ricevimento entro 8 (otto) giorni dal ricevimento della merce. In ogni caso, prima di procedere alla posa del materiale ceramico compravenduto sarà onere dell'acquirente e/o del cliente finale a cui tale obbligazione dovrà essere contrattualmente estesa, verificare la sussistenza o meno di vizi e/o difetti palesi e ciò al fine di non aggravare il danno. Eventuali reclami che dovessero riguardare il materiale già in opera verranno pertanto respinti. La posa in opera determinerà rinuncia alla garanzia per vizi palesi della merce fornita e comunque integrerà quanto disposto dall'art. 1227 c.c.. E' espressamente esclusa la garanzia per la merce classificata di seconda o terza scelta, blocchi o partite occasionali. Offerte, transazioni, accrediti concessi dai ns. Agenti o intermediari non sono validi se non confermati per iscritto dalla ns. sede. I nostri campioni sono soltanto indicativi e vengono da noi presentati al solo scopo di fornire al cliente indicazioni di massima del prodotto.
 - SOLVE ET REPETE** – Nessuna eccezione, salvo quelle di nullità, annullabilità e rescissione del contratto, può essere opposta dall'acquirente al fine di ritardare od evitare il pagamento.
 - RISERVATO DOMINIO** – La vendita della merce viene effettuata con la clausola del riservato dominio, sicché la proprietà della stessa passerà all'acquirente solo con l'integrale ed effettivo pagamento del prezzo. Il mancato pagamento anche di una sola rata produrrà lo scioglimento del contratto con la facoltà di esigere l'immediato pagamento di tutte le rate anche non scadute ovvero l'immediata restituzione della merce. In tal caso le somme versate resteranno acquisite al venditore a titolo di indennità.
 - CLAUSOLA COMPROMISSORIA** – Ad eccezione delle controversie inerenti il pagamento del prezzo ed alle relative azioni esercitate in via monitoria o nel giudizio ordinario, che rimangono di competenza dell'autorità giurisdizionale italiana, qualunque altra controversia che dovesse insorgere in ordine alla conclusione e/o esecuzione e/o risoluzione e/o interpretazione del presente contratto sarà devoluta ad un collegio di tre arbitri, nominati uno da ciascuna delle parti, ed il terzo di comune accordo o, in caso di disaccordo, dal Presidente della C.C.I.A.A. di Reggio Emilia, a richiesta della parte più diligente. La parte che intende avviare l'arbitrato deve comunicarlo all'altra parte con lettera raccomandata contenente la nomina del proprio arbitro e la sua accettazione. L'altra parte dovrà nominare il proprio arbitro nel termine di 15 giorni dalla data di ricezione della raccomandata, comunicando tale nomina e la relativa accettazione entro il termine indicato. In difetto l'alta parte potrà richiedere la nomina del secondo arbitro al Presidente della C.C.I.A.A. di Reggio Emilia. Gli arbitri decideranno secondo diritto e nel rispetto del principio del contraddittorio; il lodo dovrà essere deliberato nel termine di 90 giorni decorrenti dalla data di accettazione dell'ultimo arbitro. L'arbitrato avrà sede in Reggio Emilia.
 - FORO COMPETENTE E LEGGE APPLICABILE** – Per qualsiasi controversia è esclusivamente competente il Foro di Reggio Emilia e la legge applicabile è esclusivamente quella italiana.
 - EFFETTIVITA' DI CIASCUNA CONDIZIONE** – Le condizioni generali di vendita sopra riportate non devono assolutamente intendersi come clausole di puro stile. Esse sono effettive e rappresentano fedelmente la volontà negoziale delle parti.
- CONTRACTUAL REGULATIONS** – Subject to possible modifications or variations agreed in writing, these general conditions govern all sales contracts between us and the purchaser, and therefore both the contract entered into with acceptance of this order and any future contracts relating to supplies of our company's products ordered with subsequent and separate commissions.
 - SUPPLIES** – The price set forth herein is understood as net of transport costs, VAT and any customs duties, for goods delivered ex works our factory.
 - ORDERS** – The Principal undertakes to maintain as valid the order proposal issued to our company's sales personnel. Each order sent by our Agents is always accepted "SUBJECT TO COMPANY APPROVAL", and we therefore reserve the right not to accept or modify the order itself. The above also holds true for any free-of-charge transfers for the showroom. Before fulfilling orders, the company reserves the right to request sales information.
 - DELIVERIES** – Delivery terms are never binding; in any event, we shall not be deemed responsible for any delivery or performance delays of orders, where confirmed, due to events attributable to us, such as obstacles or difficulties in transport, strikes, lockouts, impossibility or even only difficulty in prompt procurement of raw materials. The principal, therefore, cannot in any case request the termination of the contract or claim compensation for any direct or indirect damages due to delay in delivery.
 - GRADES** – The material will be delivered in the grade as indicated in the purchase order. Therefore, requests for certain percentages of grades will be understood as simple indications and fulfilled according to production outputs.
 - TRANSPORT** – Goods travel at the Principal's own risk even if delivered carriage paid and our responsibility ceases with delivery to the carrier; therefore, complaints about any shortfalls or breakages must therefore be made exclusively to the latter.
 - PRICES** – We reserve the right to modify the prices in the price-list with 30 (thirty) days' advance notice.
 - PAYMENTS** – Payments must be made to our head office. Our acceptance of bills or non-locally issued cheques or in any case agreed payment by banker's drafts does not create an exception to this condition. Invoices not contested within 8 (eight) days from receipt are understood as accepted. Payments must be made in the ways and under the terms agreed in our commission. In the case of late payment of sums owed to us, we have the right to suspend supplies and cancel the relationships in progress. Interest for late payment must be expressly agreed with rates to be defined. In the absence of this, legal default interest will be applied.
 - CONTESTED DEFECTS** – Any contested defects of the goods that are the subject of the supply, whether apparent or hidden, must be forwarded to our head office by registered letter with return receipt within 8 (eight) days from receipt of the goods. In any case, before proceeding with laying the ceramic material purchased, it will be the responsibility of the purchaser and/or of the end customer, to whom this obligation must be contractually extended, to check the existence of apparent faults and/or defects, in order not to worsen the damage. Any complaints concerning material already laid will therefore be rejected. Laying of the material will constitute waiver of warranty for apparent defects in the goods supplied and in any case will supplement the provisions of Article 1227 of the Italian Civil Code. Warranty for goods classified as second or third grade, occasional lots or batches is expressly excluded. Offers, transactions and credits granted by our Agents or intermediaries are not valid unless confirmed in writing by our head office. Our samples are only indicative and are presented by us for the sole purpose of providing the client with a general idea of the product.
 - SOLVE ET REPETE** – No exception, save that of nullity, possibility of cancellation, and termination of the contract, can be claimed by the purchaser with the purpose of delaying or avoiding payment.
 - TITLE RETENTION** – Sale of the goods is carried out with the title retention clause, so that ownership of the same shall pass to the purchaser only with the complete and effective payment of the price. Failure to pay even one single instalment will cause termination of the contract with the right to demand immediate payment of all instalments even if not expired or the immediate return of the goods. In the latter case the seller shall retain the sums paid, by way of indemnity.
 - ARBITRATION CLAUSE** – Except for disputes relating to payment of the price and the relative actions brought in summary proceedings or in the ordinary court, which fall under the competence of the Italian legal authorities, any other dispute that may arise concerning the conclusion and/or execution and/or termination and/or interpretation of this contract shall be transferred to a board of three arbitrators, one appointed by each of the two parties and the third by common agreement or, in the case of disagreement, by the Chairman of the Reggio Emilia Chamber of Commerce, Industry, Agriculture and Small Business (C.C.I.A.A.), by request of the most diligent party. The party which intends to start up the arbitration must notify this to the other party with a registered letter containing the appointment of its own arbitrator and his/her acceptance. The other party must appoint its own arbitrator within 15 days from the date of receipt of the registered letter, notifying this appointment and relative acceptance within the time-limit indicated. If this should not be done the other party may request the Chairman of the Reggio Emilia C.C.I.A.A. to appoint the second arbitrator. The arbitrators shall decide according to law and in observance of the adversarial nature of the proceedings; the award must be resolved on within a time-limit of 90 days starting from the date of acceptance of the last arbitrator. The arbitration will take place in Reggio Emilia.
 - COURT OF JURISDICTION AND GOVERNING LAW** – For any dispute the Court of Reggio Emilia has exclusive jurisdiction and the governing law is exclusively Italian law.
 - EFFECTIVENESS OF EACH CONDITION** – The above general conditions of sale must under no circumstances be understood merely as standard clauses. They are effective and faithfully represent the contractual intent of the parties.



CERASARDA - LA CERAMICA DELLA COSTA SMERALDA
www.cerasarda.it

Headquarter

Via A. Volta 9-23/25
42013 Casalgrande (RE) · Italy
Tel. +39 0522 998411/911

Factory

Zona Ind.le Settore 7 · Circonv. Ovest dir. Golfo Aranci
07026 Olbia (SS) · Italy
Tel. +39 0789 567311



COSTA SMERALDA